



Characteristics



- Energy saving heat pump air curtains: Up to 70% reduction in costs and CO₂ emissions (heating mode).
- Stylish, discreet and contemporary design adaptive to any interior architecture.
- Smooth front panel can be customized with logotypes, lighting, lettering or safety and informative signals, according to the client requirements.
- Self-supporting steel rounded casing with edgeless plastic side covers, finished in structural epoxy-polyester painting white colour RAL9016 as standard. Other colours are available on request.
- Hidden top air entrance, avoiding the inside view of the unit and the inlet grille.
- Anodized aluminium outlet vanes, airfoil shaped, adjustable from 0 to 15° each side.
- EC Double-inlet centrifugal fans driven by an external rotor motor and low noise level, with very low consumption efficiency fans.
- Includes direct expansion coil with sensors. Optional condensate water pump.
- CS-5DX-NE Plug&Play control with 5 speeds and telephone cable 7m included.
- Requires DX Interface KIT adapted for air curtain and programmable control, please consult.
- Ready to connect to MIDEA Inverter outdoor heat pump unit (R410A) with expansion valve, not included, the customer should purchase it.

Specifications

Model	Airflow m ³ /h	Outdoor Unit (*) 230Vx1	Outdoor Unit (*) 400Vx3	Power Fans 230V-50Hz kW	Current Fans 230V-50Hz A	Noise Level (5 m) dB(A)	Weight kg
SMART ECM 1000 DX7-MD	1640	MOCA30U-24HFN1-QRD0	-	0,142	1,24	54	39
SMART ECM 1500 DX11-MD	2460	MOD30U-36HFN1-QRD0	MOD30U-36HFN1-RRD0	0,213	1,86	55	58
SMART ECM 2000 DX16-MD	3280	MOE30U-48HFN1-QRD0	MOE30U-48HFN1-RRD0	0,284	2,48	56	73
SMART ECG 1000 DX10-MD	2190	MOD30U-36HFN1-QRD0	MOD30U-36HFN1-RRD0	0,213	1,86	59	44
SMART ECG 1500 DX15-MD	2920	MOE30U-48HFN1-QRD0	MOE30U-48HFN1-RRD0	0,284	2,48	60	64
SMART ECG 2000 DX18-MD	4380	-	MOE30U-55HFN1-RRD0	0,426	3,72	61	83
SMART ECG 2000 DX22/2-MD	4380	2x MOD30U-36HFN1-QRD0	2x MOD30U-36HFN1-RRD0	0,426	3,72	61	83
SMART ECG 2500 DX29/2-MD	5110	2x MOE30U-48HFN1-QRD0	2x MOE30U-48HFN1-RRD0	0,497	4,34	62	87
SMART ECG 3000 DX32/2-MD	5840	2x MOE30U-48HFN1-QRD0	2x MOE30U-48HFN1-RRD0	0,568	5,96	63	99

22/2 Double circuit and two outdoor units of 11kW. 29/2 and 32/2 Double circuit and two outdoor units of 16kW.

(*) Includes direct expansion valve.

MIDEA Inverter Outdoor Units	Heating Capacity kW	Heating Power kW	SCOP or COP (*) W/W	Cooling Capacity kW	Cooling Power kW	SEER or EER (*) W/W	Power Supply	Pipes Gas Liquid inch	Pipes Maximum Length m	Pipes Maximum Height m
MOCA30U-24HFN1-QRD0	7,6	1,8	4,22	7,0	2,13	3,28	230Vx1	5/8 3/8	50	25
MOD30U-36HFN1-QRD0	11,1	2,9	3,82	10,5	3,95	2,65	230Vx1	5/8 3/8	65	30
MOD30U-36HFN1-RRD0	11,1	2,9	3,82	10,5	3,95	2,65	400Vx3	5/8 3/8	65	30
MOE30U-48HFN1-QRD0	16,1	4,4	3,65	14,1	5,10	2,76	230Vx1	5/8 3/8	65	30
MOE30U-48HFN1-RRD0	16,1	4,4	3,65	14,1	5,10	2,76	400Vx3	5/8 3/8	65	30
MOE30U-55HFN1-RRD0	17,6	5,5	3,20	16,1	6,30	2,55	400Vx3	5/8 3/8	65	30

Energy efficiency: SCOP/SEER seasonal ≤12kW, COP/EER >12kW.

Outdoor unit capacities depending on standard conditions: heating 20°CDB indoor / 7°CDB and 6°CWB outdoor, cooling 27°CDB and 19°CWB indoor / 35°CDB outdoor.

When adverse weather conditions, the outdoor unit capacity can decrease. It is recommendable to oversize the units.



Dimensions

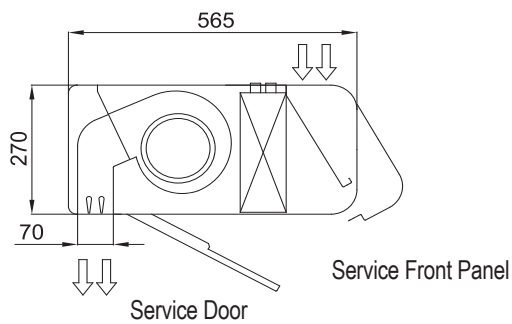
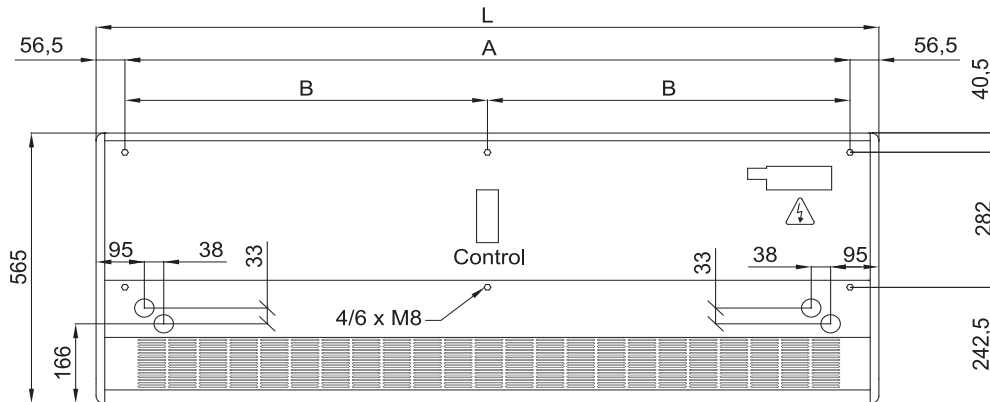

	L	A	B
SMART 1000	1034	920	-
SMART 1500	1534	1420	710
SMART 2000	2034	1920	960
SMART 2500	2534	2420	1210
SMART 3000	3034	2920	1460

Finishes and Details

