



Characteristics



- Energy saving heat pump air curtains: Up to 70% reduction in costs and CO₂ emissions (heating mode).
- Self-supporting casing construction made of galvanized steel plate, finished in structural epoxy-polyester painting white colour RAL9016 as standard. Other colours or stainless steel are available on request.
- Front panel with option to customize and the possibility of including personalized logos, signs, graphic designs, images, etc.
- The inlet areas are located behind the front panel. They do not need maintenance.
- Anodized aluminium outlet vanes, airfoil shaped, adjustable from 0 to 15° each side.
- EC Double-inlet centrifugal fans driven by an external rotor motor and low noise level, with very low consumption efficient fans.
- Includes direct expansion coil with sensors. Optional condensate water pump.
- CS-5DX-NE Plug&Play control with 5 speeds and telephone cable 7m included.
- Requires HITACHI DX Interface KIT adapted for air curtain with expansion valve and programmable control, please consult.
- Ready to connect to HITACHI Inverter outdoor heat pump unit (R410A), not included, the customer should purchase it.

Specifications

Model	Airflow m ³ /h	Outdoor Unit 230Vx1	Outdoor Unit 400Vx3	Hitachi Kit Interface DX (*)	Power Fans 230V-50Hz kW	Current Fans 230V-50Hz A	Noise Level (5 m) dB(A)	Weight kg
DAM ECM 1000 DX8-HI	1640	RAS-3HVNC1	-	EXV-3.0E2	0,142	1,24	56	43
DAM ECM 1500 DX11-HI	2460	RAS-4HVNC1E	RAS-4HNC1E	EXV-4.0E2	0,213	1,86	57	64
DAM ECM 2000 DX16-HI	3280	RAS-6HVNC1E	RAS-6HNC1E	EXV-6.0E2	0,284	2,48	58	81
DAM ECM 2500 DX21-HI	4100	-	RAS-8HNCE	EXV-8.0E2	0,355	3,10	59	89
DAM ECM 3000 DX26-HI	4920	-	RAS-10HNCE	EXV-10.0E2	0,426	3,72	60	103
DAM ECG 1000 DX8-HI	2190	RAS-3HVNC1	-	EXV-3.0E2	0,213	1,86	61	48
DAM ECG 1500 DX13-HI	2920	RAS-5HVNC1E	RAS-5HNC1E	EXV-5.0E2	0,284	2,48	62	70
DAM ECG 1500 DX15-HI	2920	RAS-6HVNC1E	RAS-6HNC1E	EXV-6.0E2	0,284	2,48	62	70
DAM ECG 2000 DX22-HI	4380	-	RAS-8HNCE	EXV-8.0E2	0,426	3,72	63	91
DAM ECG 2500 DX22-HI	5110	-	RAS-8HNCE	EXV-8.0E2	0,497	4,34	64	97
DAM ECG 2500 DX28-HI	5110	-	RAS-10HNCE	EXV-10.0E2	0,497	4,34	64	97
DAM ECG 3000 DX28-HI	5840	-	RAS-10HNCE	EXV-10.0E2	0,568	5,96	65	111

(*) Includes direct expansion valve.

HITACHI Utopia IVX Confort (*) Outdoor Units	Heating Capacity kW	Heating Power kW	SCOP or COP	Cooling Capacity kW	Cooling Power kW	SEER or EER	Power Supply	Pipes Gas Liquid inch	Pipes Maximum Length m	Pipes Maximum Height m
RAS-3HVNC1	8,0	2,00	4,00	7,1	2,26	3,14	230Vx1	5/8 3/8	50	30
RAS-4HVNC1E	11,2	2,45	4,57	10,0	2,70	3,70	230Vx1	5/8 3/8	70	30
RAS-4HNC1E	11,2	2,45	4,57	10,0	2,70	3,70	400Vx3	5/8 3/8	70	30
RAS-5HVNC1E	14,0	3,60	3,89	12,5	3,71	3,37	230Vx1	5/8 3/8	75	30
RAS-5HNC1E	14,0	3,60	3,89	12,5	3,71	3,37	400Vx3	5/8 3/8	75	30
RAS-6HVNC1E	16,0	4,29	3,73	14,0	4,29	3,26	230Vx1	5/8 3/8	75	30
RAS-6HNC1E	16,0	4,29	3,73	14,0	4,29	3,26	400Vx3	5/8 3/8	75	30
RAS-8HNCE	22,4	5,88	3,81	20,0	5,95	3,36	400Vx3	1 3/8	100	30
RAS-10HNCE	28,0	7,71	3,63	25,0	8,28	3,02	400Vx3	1 1/2	100	30

(*) Also compatible with outdoor units Utopia ES, VRF Centrifugal, Utopia IVX Premium.

Energy efficiency: SCOP/SEER seasonal ≤12kW, COP/EER >12kW.

Outdoor unit capacities depending on standard conditions: heating 20°CDB indoor / 7°CDB and 6°CWB outdoor, cooling 27°CDB and 19°CWB indoor / 35°CDB outdoor.

When adverse weather conditions, the outdoor unit capacity can decrease. It is recommendable to oversize the units.



Characteristics



- Energy saving heat pump air curtains: Up to 70% reduction in costs and CO₂ emissions (heating mode).
- Self-supporting casing construction made of galvanized steel plate, finished in structural epoxy-polyester painting white colour RAL9016 as standard. Other colours or stainless steel are available on request.
- Front panel with option to customize and the possibility of including personalized logos, signs, graphic designs, images, etc.
- The inlet areas are located behind the front panel. They do not need maintenance.
- Anodized aluminium outlet vanes, airfoil shaped, adjustable from 0 to 15° each side.
- EC Double-inlet centrifugal fans driven by an external rotor motor and low noise level, with very low consumption efficient fans.
- Includes direct expansion coil with sensors. Optional condensate water pump.
- CS-5DX-NE Plug&Play control with 5 speeds and telephone cable 7m included.
- Requires HITACHI VRF Interface KIT adapted for air curtain with expansion valve and programmable control, please consult.
- Ready to connect to HITACHI VRF outdoor heat pump unit (R410A), not included, the customer should purchase it.

Specifications

Model	Airflow m ³ /h	Hitachi Kit Interface VRF (*)	Power Fans 230V-50Hz kW	Current Fans 230V-50Hz A	Noise Level (5 m) dB(A)	Weight kg
DAM ECM 1000 VRF8-HI	1640	EXV-3.0E2	0,142	1,24	56	43
DAM ECM 1500 VRF12-HI	2460	EXV-4.0E2	0,213	1,86	57	64
DAM ECM 2000 VRF16-HI	3280	EXV-6.0E2	0,284	2,48	58	81
DAM ECM 2000 VRF19-HI	3280	EXV-8.0E2	0,284	2,48	58	81
DAM ECM 2500 VRF21-HI	4100	EXV-8.0E2	0,355	3,10	59	89
DAM ECM 2500 VRF24-HI	4100	EXV-10.0E2	0,355	3,10	59	89
DAM ECM 3000 VRF26-HI	4920	EXV-10.0E2	0,426	3,72	60	103
DAM ECG 1000 VRF10-HI	2190	EXV-4.0E2	0,213	1,86	61	48
DAM ECG 1500 VRF13-HI	2920	EXV-5.0E2	0,284	2,48	62	70
DAM ECG 1500 VRF15-HI	2920	EXV-6.0E2	0,284	2,48	62	70
DAM ECG 2000 VRF20-HI	4380	EXV-8.0E2	0,426	3,72	63	91
DAM ECG 2000 VRF24-HI	4380	EXV-8.0E2	0,426	3,72	63	91
DAM ECG 2500 VRF25-HI	5110	EXV-8.0E2	0,497	4,34	64	97
DAM ECG 2500 VRF29-HI	5110	EXV-10.0E2	0,497	4,34	64	97
DAM ECG 3000 VRF29-HI	5840	EXV-10.0E2	0,568	5,96	65	111

(*) Includes direct expansion valve.

HITACHI VRF Outdoor Units

Utopia ES / Utopia IVX Confort

VRF Centrifugal

Utopia IVX Premium / Set Free Mini / Front Flow

Set Free



When adverse weather conditions, the outdoor unit capacity can decrease. It is recommendable to oversize the units.



Dimensions

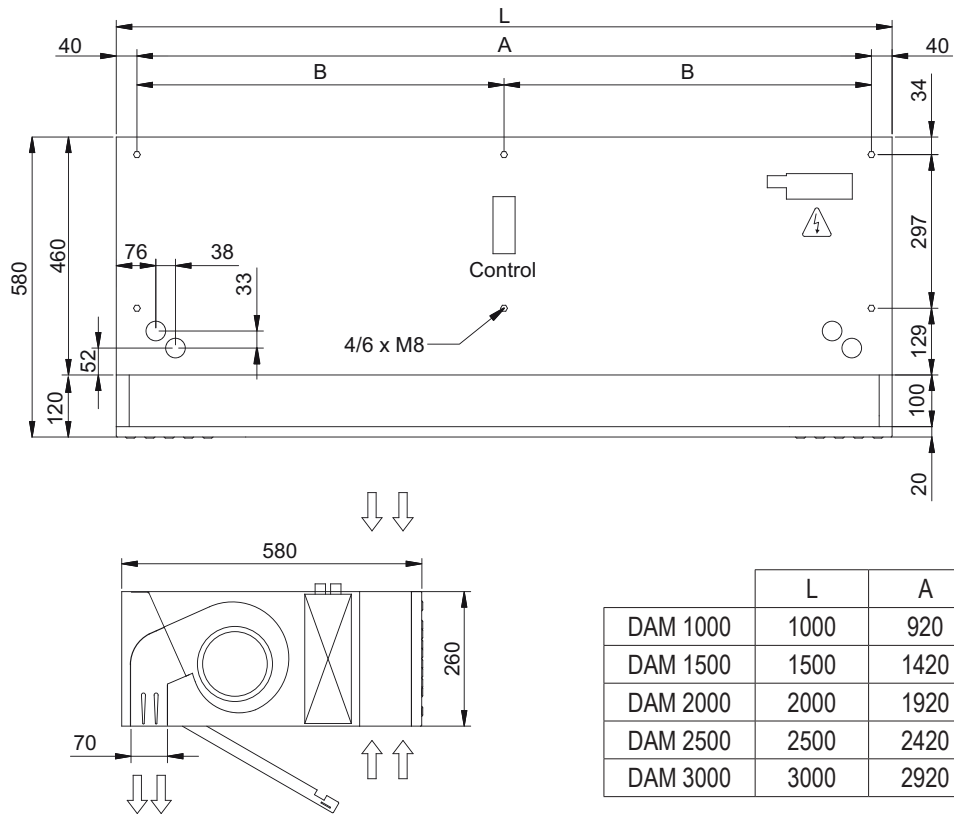

Finishes and details

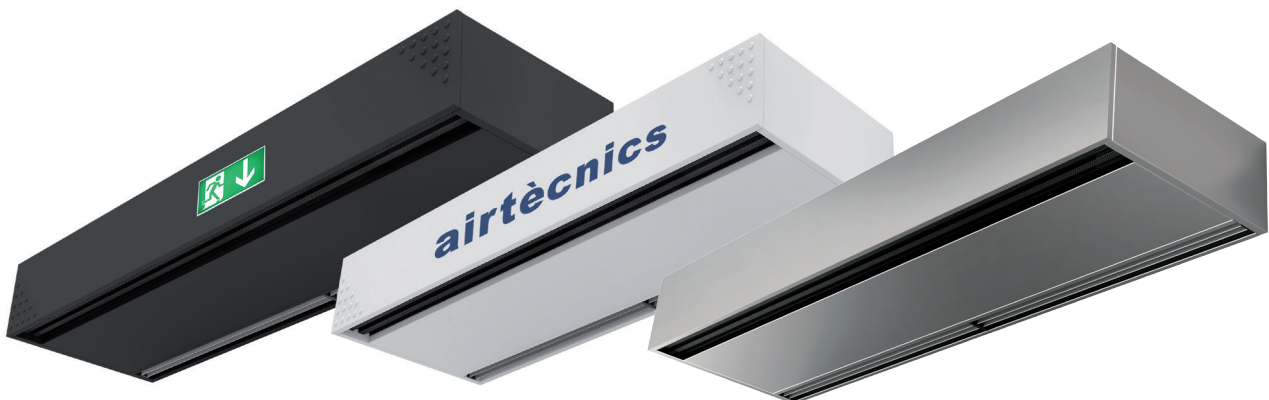

- Painted any RAL colour
- Available in stainless steel AISI 304 (brushed)
- Customizable with logos, signs, vinyls, etc.