

Air Curtain with Heat Pump LG



INSTALATION, OPERATION AND MAINTENANCE MANUAL

Air curtains with LCD Advanced PRO control and Heat Pump
LG 1:1&VRF system

With HEATING and COOLING:
Windbox, Recessed Windbox, Smart, Dam and Recessed Dam with
LG Pump and Kit (*)

Only HEATING:
Invisair, Rotowind, Rund and Zen with LG Pump (*)



Please, reed these instructions carefully before attempting installation

SECURITY ADVISE SIMBOLS



Attention, Danger, Safety Advice!



Danger from electric current or high voltage!



Injuries risk!



Danger! Do not stay underneath: Heavy load.



Important information.

(*) This manual complements with the LG's Kit (1:1 or VRF)



This manual indicates how to connect the air curtains with the heat pump external unit. It is necessary to complement this information with the heat pump manufacturer manual for a correct installation and maintenance of the set.

INDEX

CAUTIONS	3
INSTALLATION	4
CONNECTION DIAGRAM.....	11
CONNECTIONS	12
TRANSPORTATION AND STORAGE	14
OPERATING INSTRUCTIONS.....	15
AIR CURTAINS WORKING MODE	21
DATASHEET.....	22
MAINTENANCE INSTRUCTIONS	31
REPAIRS AND REPLACEMENTS	37
TROUBLESHOOTING	43
DECLARATION OF CONFORMITY.....	45
IDENTIFICATOR	46
GUARANTEE	46

CAUTIONS

IMPORTANT INSTRUCTIONS

Please before installing or using the air curtain, read carefully all instructions and considerations to reduce the risk of fire, electric shock, injury to people or damage to the air curtain itself. For that is recommended to follow the next basic precautions:

1. Use the air curtain only in the manner intended by the manufacturer and described in this manual. Any other use not recommended may increase the risks mentioned before.
2. Installation work and electrical wiring must be done by a qualified technician. Be also careful to not damage electrical wiring or hidden utilities when cutting or drilling into a wall or ceiling.
3. All air curtains with heat pump include a precharge of 4 to 6 bars of nitrogen. Discharge the pressure before performing the installation connections.
4. The air curtain is a heavy appliance and for that matter it must be elevated with proper lifting tools to prevent injuries to the people who install it.
5. Before servicing or cleaning the unit, switch power off at service pannel and lock the service disconnecting the means to prevent being switched on accidentally. When the service protection elements cannot be locked, securely fasten a prominent warning device, such as a tag, to the service panel.
6. It's HIGHLY recommended to do a periodical maintenance as stated in this manual section following the instructions given to clean the inlet grille, visual inspect each part and prevent any possible malfunction or issue of the air curtain before it happens.
7. Do not operate any air curtain after it malfunctions. Disconnect power at service panel and have air curtain inspected by a qualified technician before reusing.
8. To disconnect the air curtain, turn the control "OFF", wait 10 minutes for the device to stop completely and then turn off power supply to the air curtain.
9. The air curtains with heating are hot when in use. To avoid burns, do not let bare skin touch hot surfaces. Keep combustible materials, such as furniture, pillows, bedding, papers, clothes, etc at least 3cm (1 inch) from the top, back, front, sides and at least 180cm (6 feet) from the discharge of the air curtain.
10. To prevent a fire, do not block the air intake or discharge of the air curtain in any manner. Also prevent any foreign objects to enter any ventilation or exhaust opening as it may cause an electric shock, fire or damage the air curtain.
11. The air curtain has hot and may have arcing or sparking parts inside. Do not use it in areas where gasoline, paint or flammable vapors or liquids are used or stored.
12. Extreme caution is necessary when any air curtain is used by or near children, elderly or invalids, and whenever the air curtain is left operating unattended.
13. Some air curtain may include a visual alarm to warn that parts of the air curtain are getting excessively hot. If the overheating alarm is active because inside the temperature is rising too much, then the air curtain protects itself changing the functioning by increasing ventilation speeds and/or reducing heating stages. Check Troubleshooting part in this manual for more info about how to proceed.
14. Air curtains must not be installed outdoors unless is intended for outdoor use. If so, the air curtain should be always protected against rain and it's recommended a special protection to prevent corrosion and other issues caused by the environment (optional).
15. The optimal working temperature of the fans is between 5°C and 40°C (41°F to 104°F) to protect the electrical components and at most should not exceed 50°C (122°F).

SAVE THESE INSTRUCTIONS

INSTALLATION

Tips and recommendations for a good installation

LENGTH

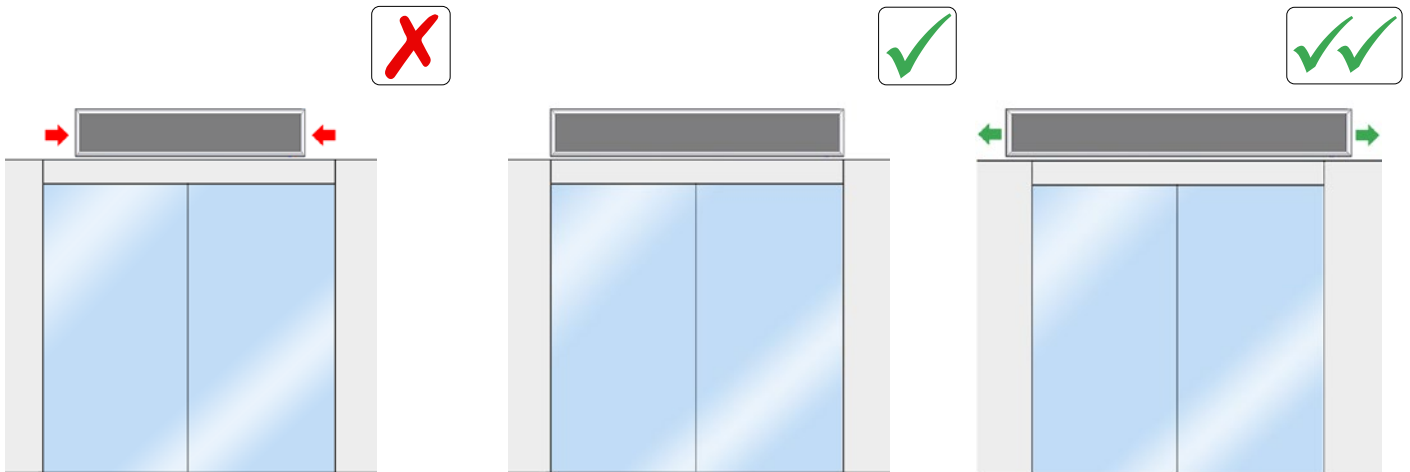

CENTERED / HEIGHT

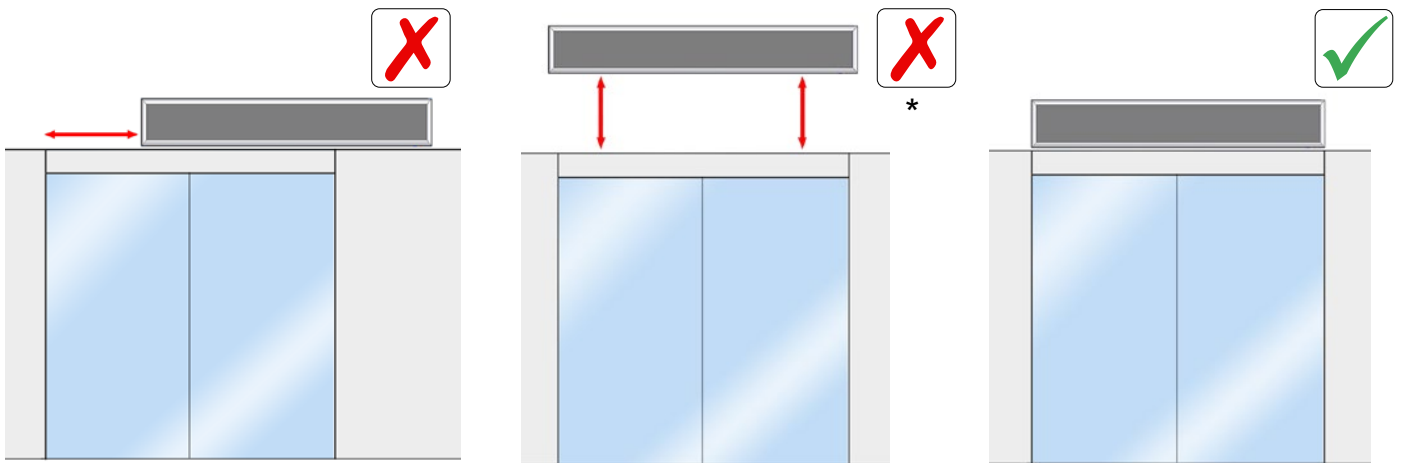

(*) Unless it has been designed to be installed at that height.

DOOR DISTANCE

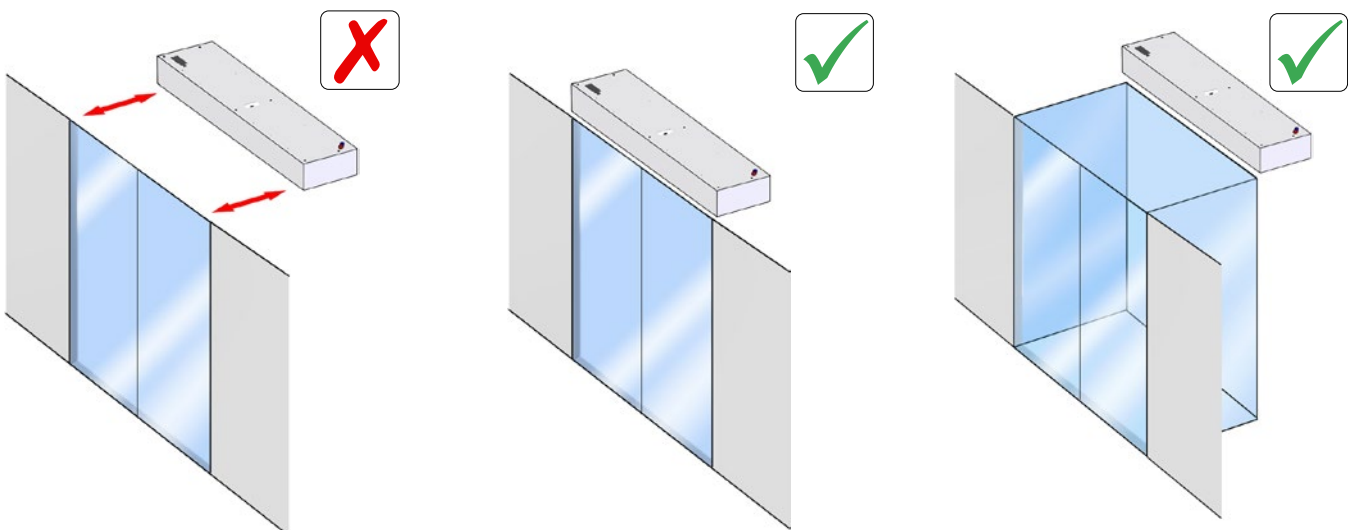

AIR DISCHARGE

AIR ASPIRATION

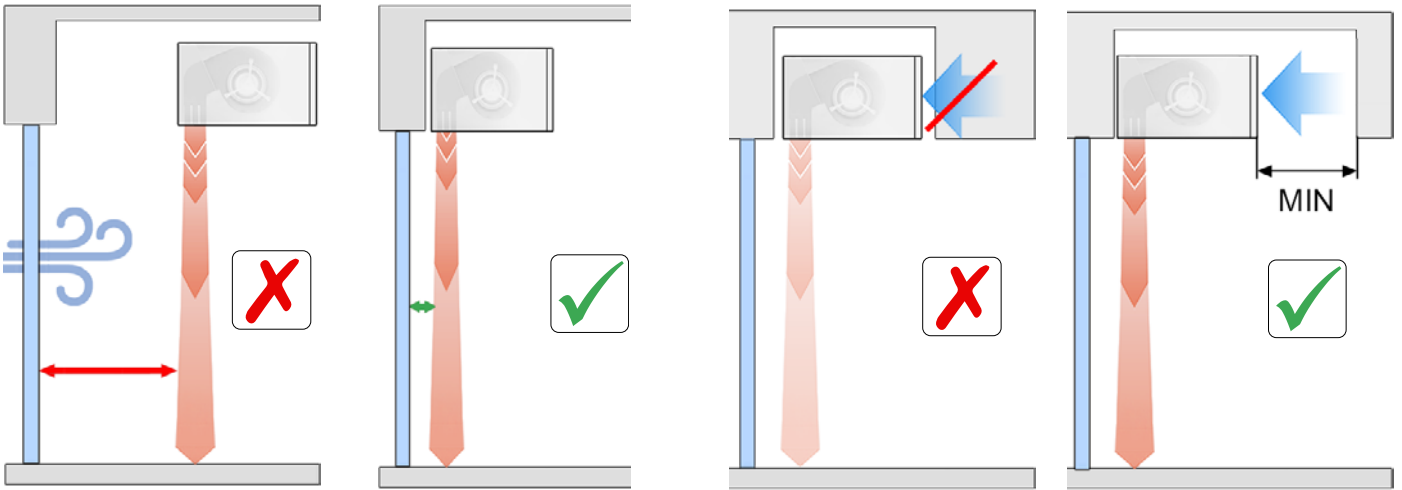



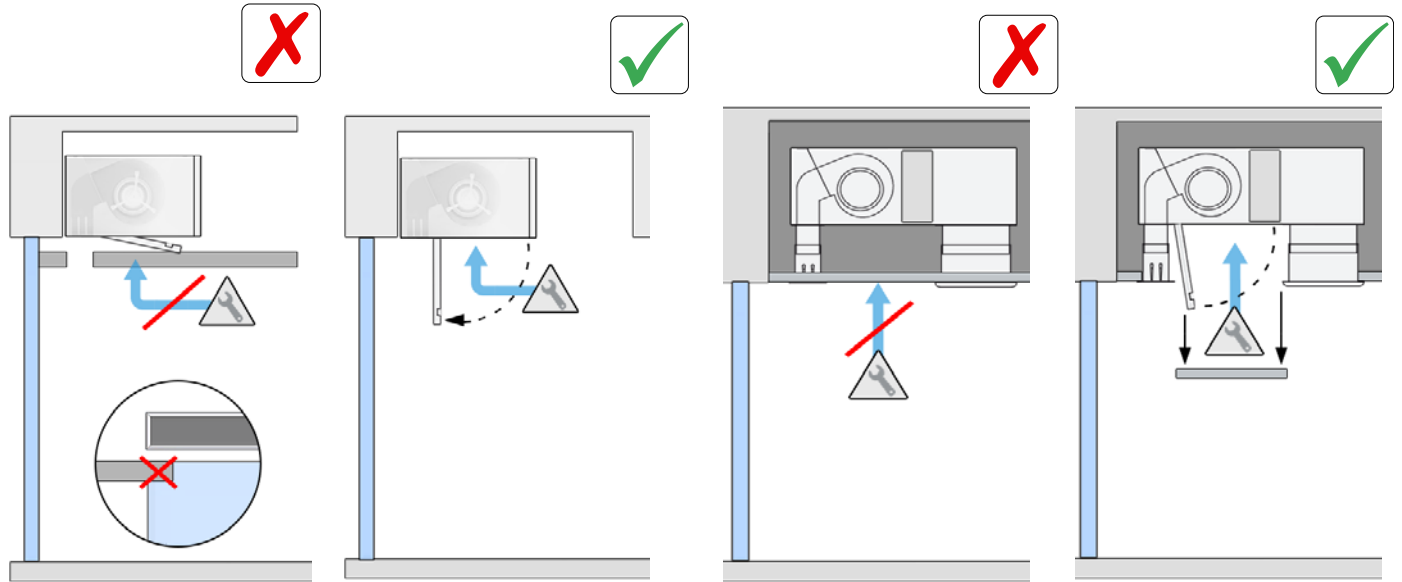

MAINTENANCE ACCESSIBILITY

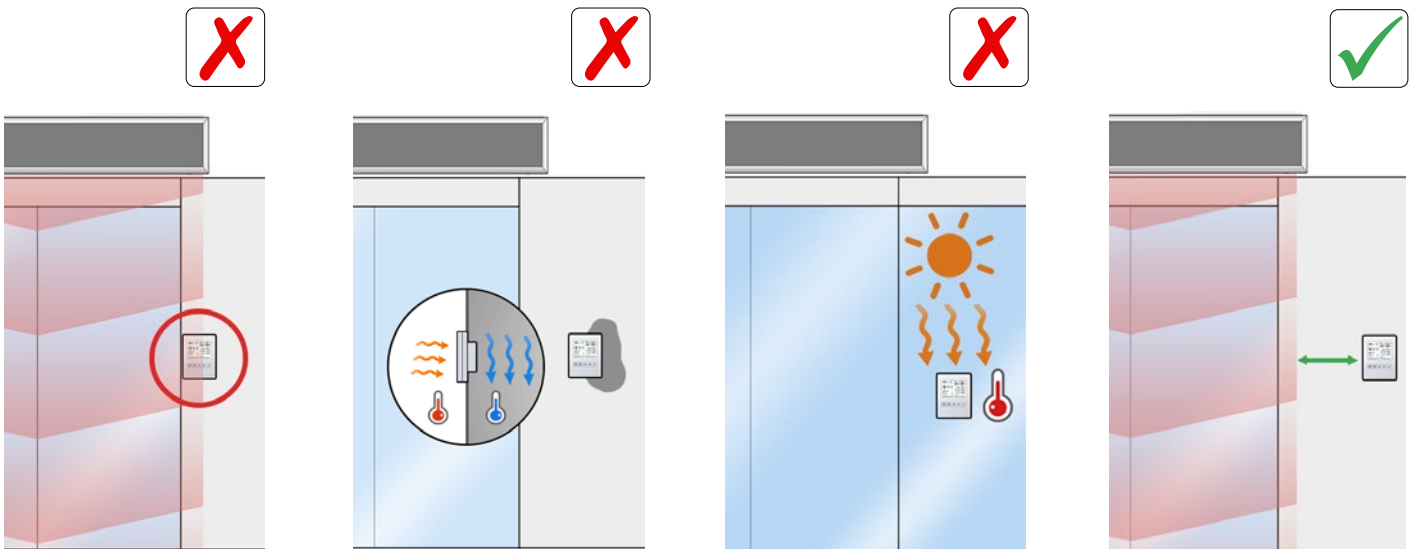

CONTROL (CLEVER)



	<p>Installation work, connection, disconnection, electrical wiring, maintenance and service must be done by qualified people observing these instructions and in accordance with all applicable norms and standards. If the unit is operated with additional controller, please consider its specific instructions.</p>
	<p>For manipulation safety, being it assembling, transport or maintenance duties it's a must to wear the correct individual protection equipment recommended. Those being gloves, insulating shoes, goggles and helmet.</p>
	<p>There is no need to open the service door to connect the air curtain. All connections of power supply, control, DX pipes (when the model is a heat pump) and fixations are external. They are placed on top of the units. Depending of the model, inside of them may be auxiliar connectors like temperature sensors, electrovalves, etc.</p>
	<p>For safety, the air curtains never have to be stopped by disconnecting them from the main supply, always through the controller and waiting 10 minutes at least to disconnect the main supply. In case to not follow these instructions, the internal parts of the air curtain can be damaged.</p>

Windbox Model

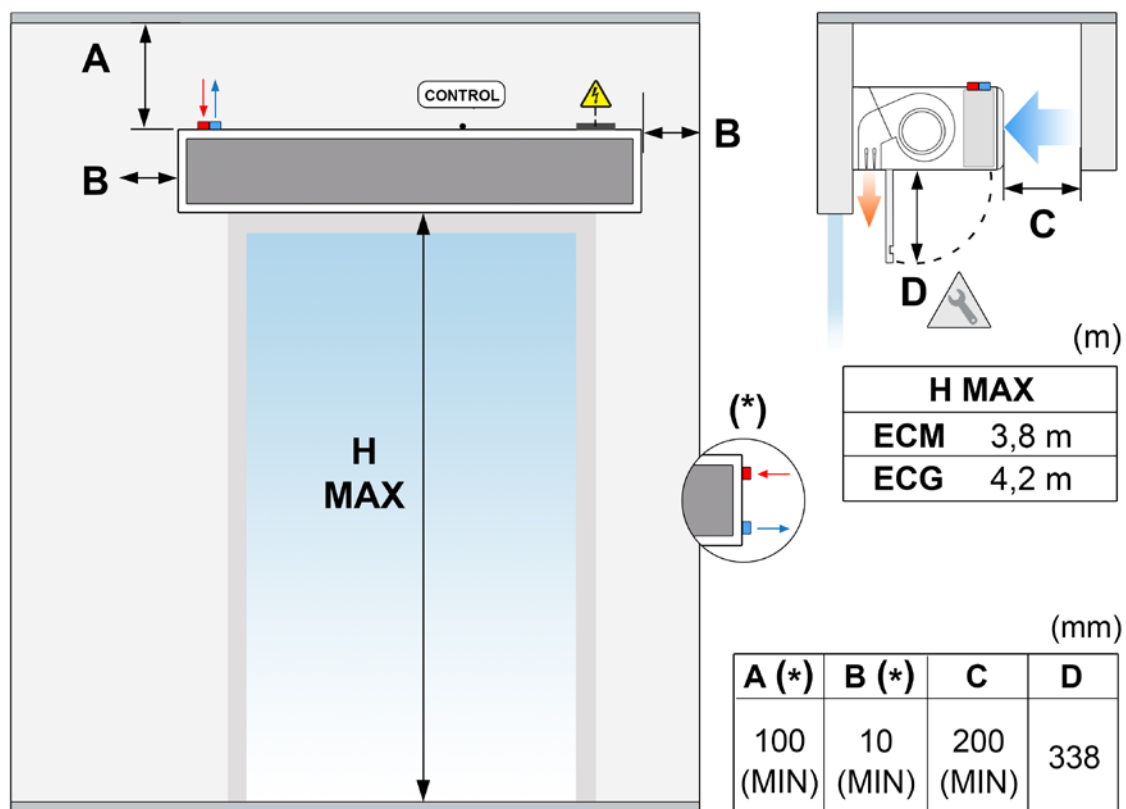

H MAX. Maximum recommended range, MIN. Recommended minimum distance.

(*) Standard units. Under demand, this distance can be reduced to 10 mm when the connections are located inside the air curtain and the pipes outlet are on the side. In this case the distance B will be of 100 mm.

The minimum recommended distance between the suction grille and any obstacle is 200 mm (Dimension C).

Dimension D: service opening distance.

DAM Model

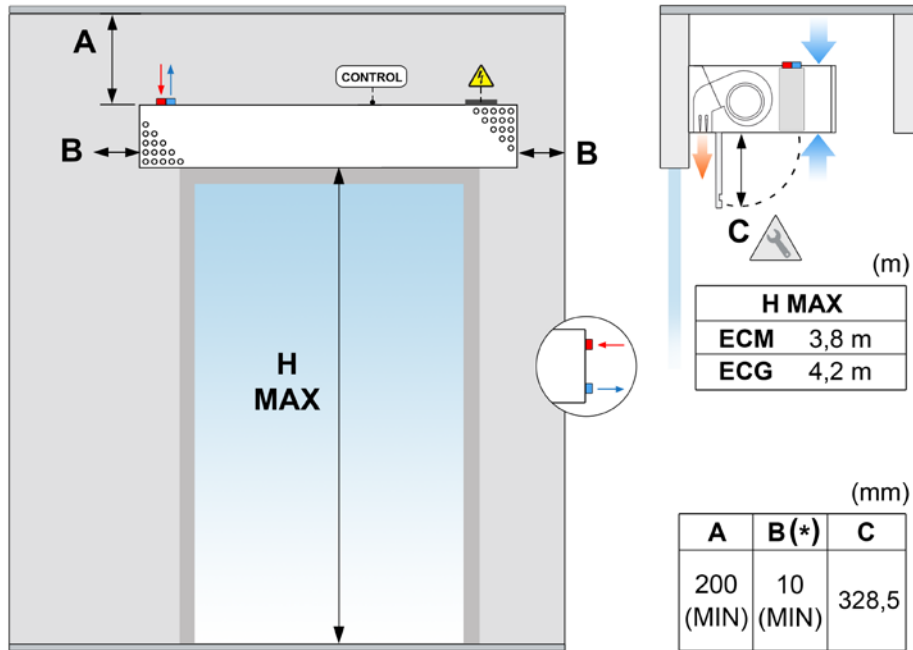

H MAX. Maximum recommended range, MIN. Recommended minimum distance.

(*) Standard units. Under demand, the distance "B" will be modified to 100 mm when the outlet of pipes is located on the side.

The minimum recommended distance between the suction grille and any obstacle is 200 mm for air curtains DAM (Dimension A).

Dimension C: service opening distance.

Recessed Windbox Model

H MAX. Maximum recommended range, MIN. Recommended minimum distance.

(*) Standard units. Under demand, this distance can be reduced to 10 mm when the connections are located inside the air curtain and the pipes outlet are on the side. In this case the distance B will be of 100 mm.

The minimum recommended distance between the suction grille and any obstacle is 200 mm.

Dimension C: service opening distance.

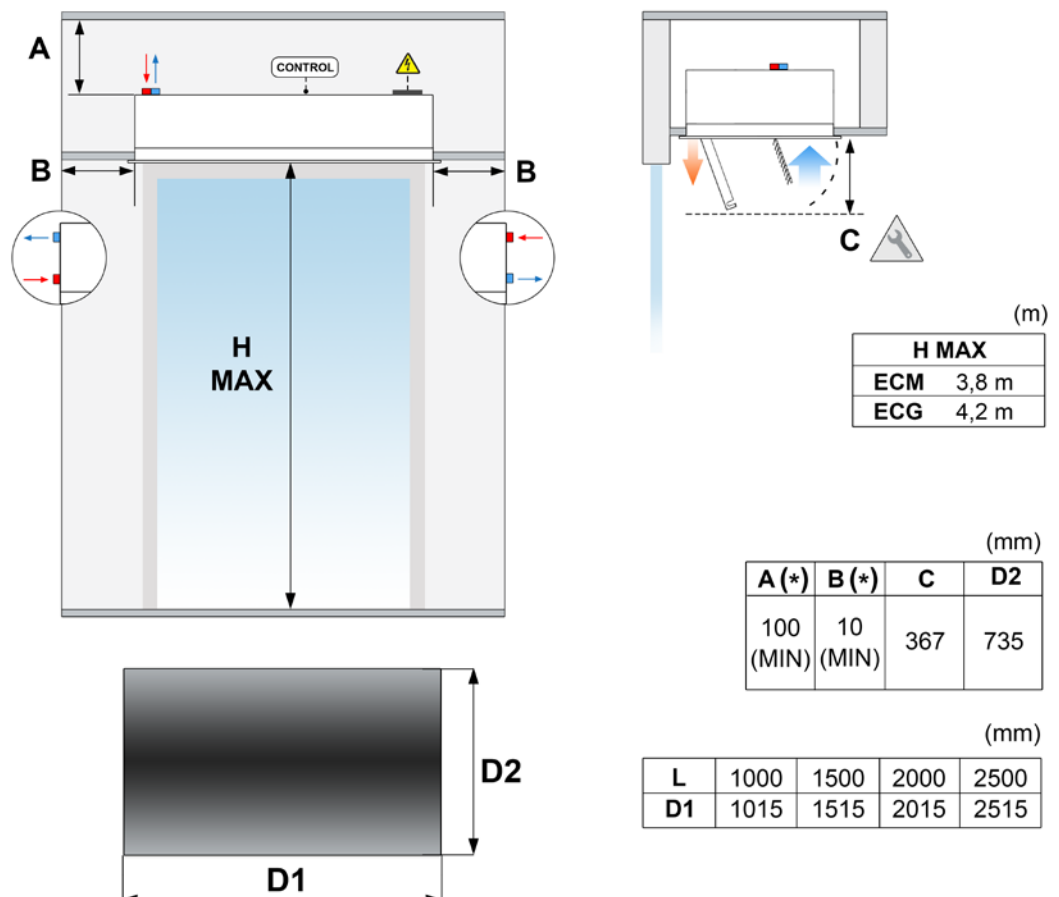

Recessed DAM Model

H MAX. Maximum recommended range, MIN. Recommended minimum distance.

(*) Standard units. Under demand, this distance can be reduced to 10 mm when the connections are located inside the air curtain and the pipes outlet are on the side. In this case the distance B will be of 100 mm.

The minimum recommended distance between the suction grille and any obstacle is 200 mm (Dimension C). Dimension D: service opening distance.

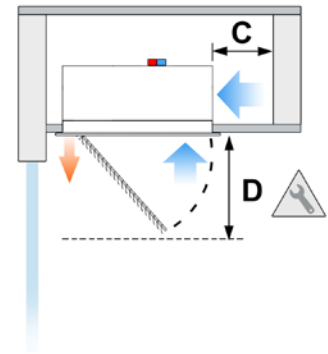
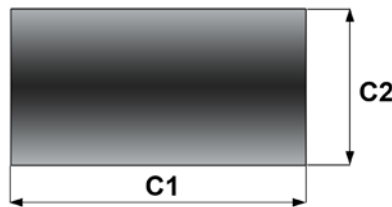
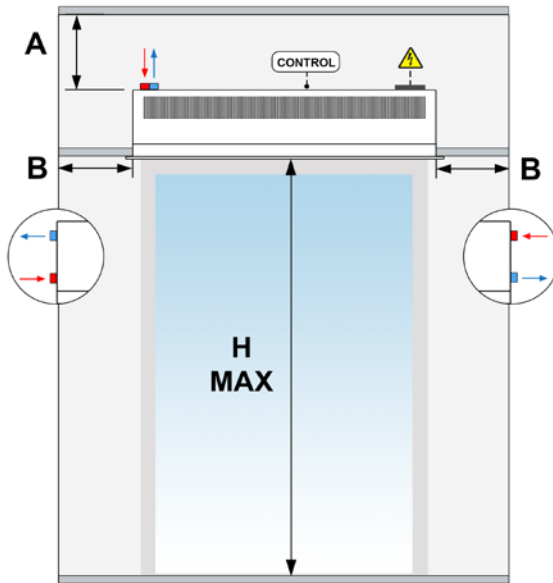

H MAX (m)	
ECM	3,8 m
ECG	4,2 m

(mm)				
A (*)	B (*)	C	D	C2
100 (MIN)	10 (MIN)	200 (MIN)	532	595

(mm)				
L	1000	1500	2000	2500
C1	1015	1515	2015	2515

Invisair Model

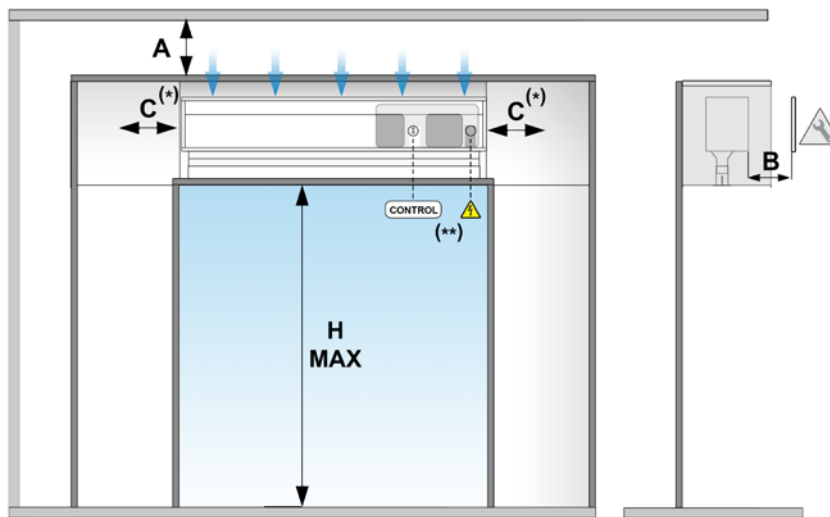

H MAX (m)	
ECG	4,2 m

(mm)					
A	B	C(*)	L1	L2	L3
200 (MIN)	250 (MIN)	10 (MIN)	1500	200	100
			2000		
			2500		

H MAX. Maximum recommended range, MIN. Recommended minimum distance.

The minimum recommended distance between the suction grille and any obstacle is 200 mm (Dimension A).

(*) Standard units. Under demand, the distance "C" will be modified to 100 mm when the outlet of pipes is located on the side.

Dimension B: service opening distance.

Smart Model

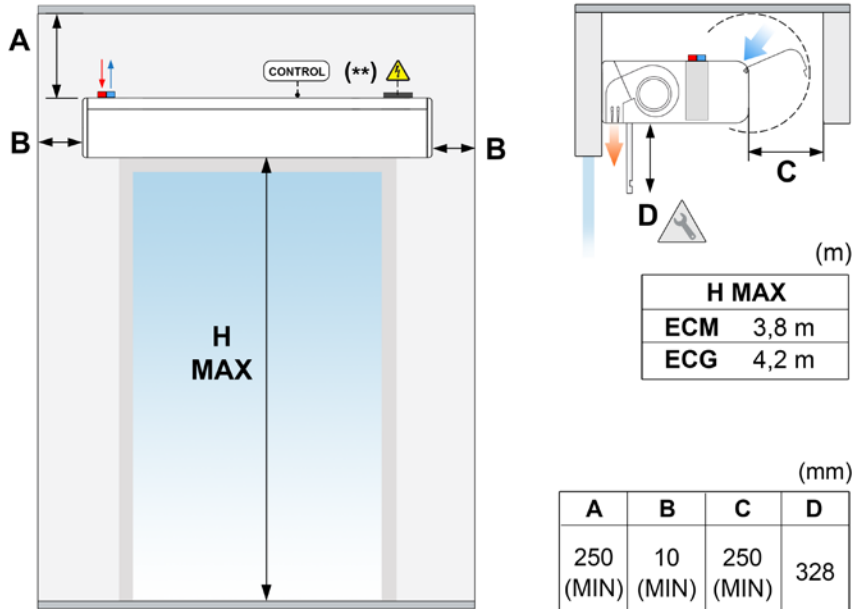

H MAX. Maximum recommended range, MIN. Recommended minimum distance.
 The minimum distance to open the front panel is 250 mm (Dimension C).
 Dimension D: service opening distance.

Zen Model

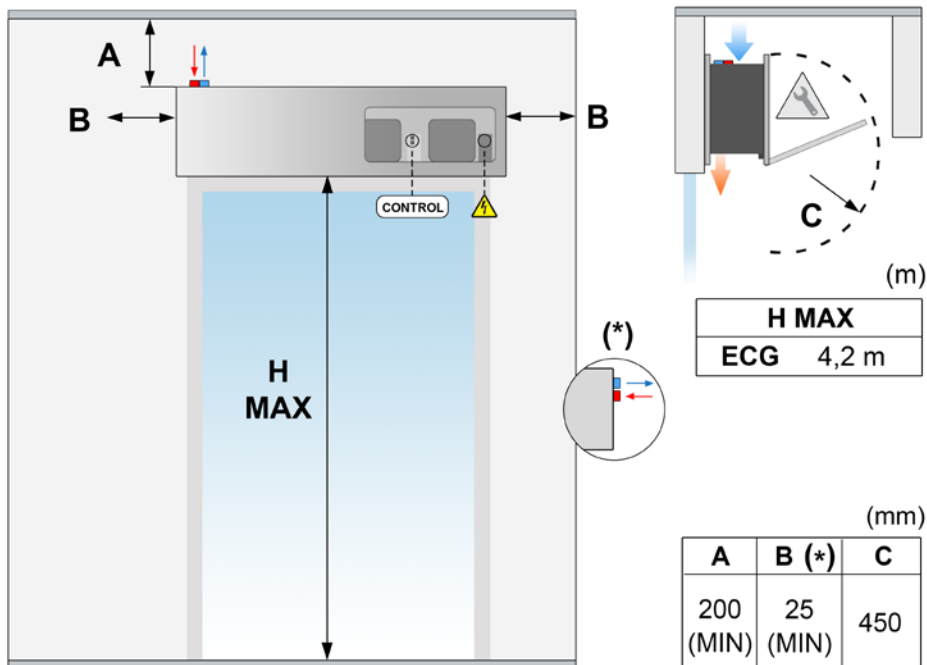

H MAX. Maximum recommended range, MIN. Recommended minimum distance.

(*) Standard units. Under demand, the distance "B" will be modified to 100 mm when the outlet of pipes is located on the side.

The minimum recommended distance between the suction grille and any obstacle is 200 mm (Dimension A).
 Dimension C: service opening distance.

Rund Model

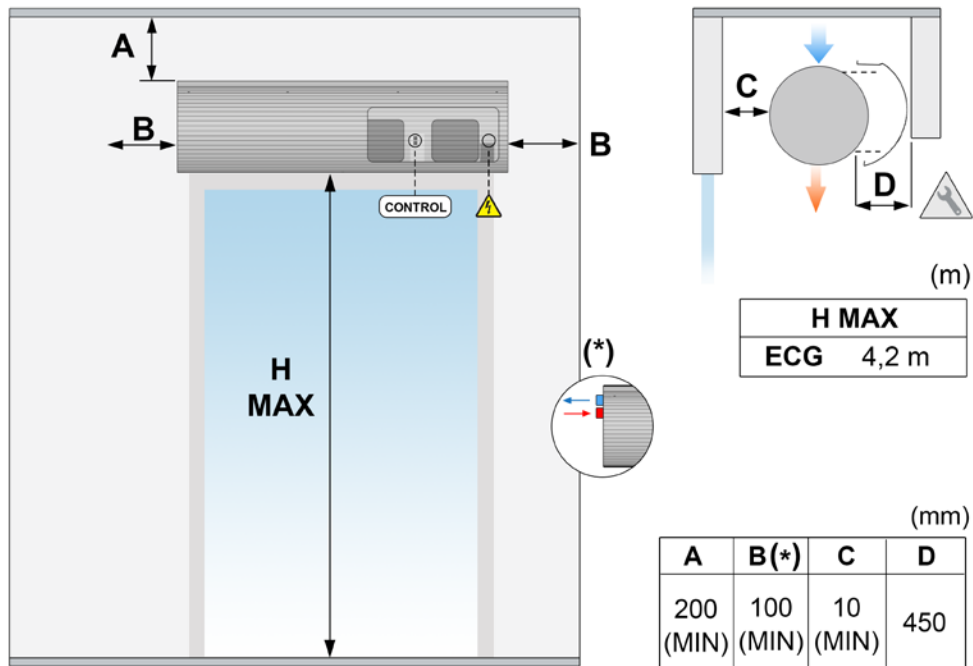

H MAX. Maximum recommended range, MIN. Recommended minimum distance.

(*) Standard units. Under demand, this distance can be reduced to 10 mm when the connections are located inside the air curtain and the pipes outlet are on the back part. In this case the distance C will be of 100 mm. The minimum recommended distance between the suction grille and any obstacle is 200 mm (Dimension A). Dimension D: service opening distance.

Rotowind Model

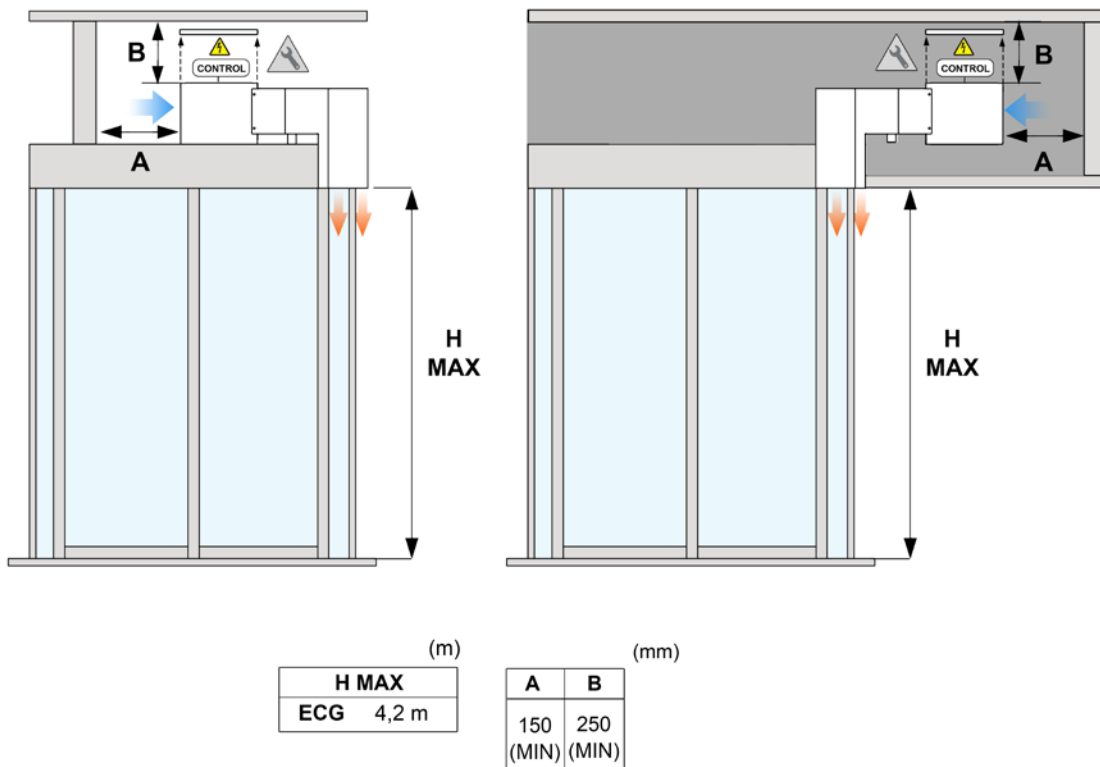

H MAX. Maximum recommended range, MIN. Recommended minimum distance.

The minimum recommended distance between the suction grille and any obstacle is 150 mm (Dimension A). Dimension B: service opening distance.

CONNECTIONS

Power Supply

Air Curtain: to connect the power supply there is a black connection box located on the outside of the air curtain except for the Rund and Zen air curtain models, which is located inside. The standard power supply is 230Vx1.

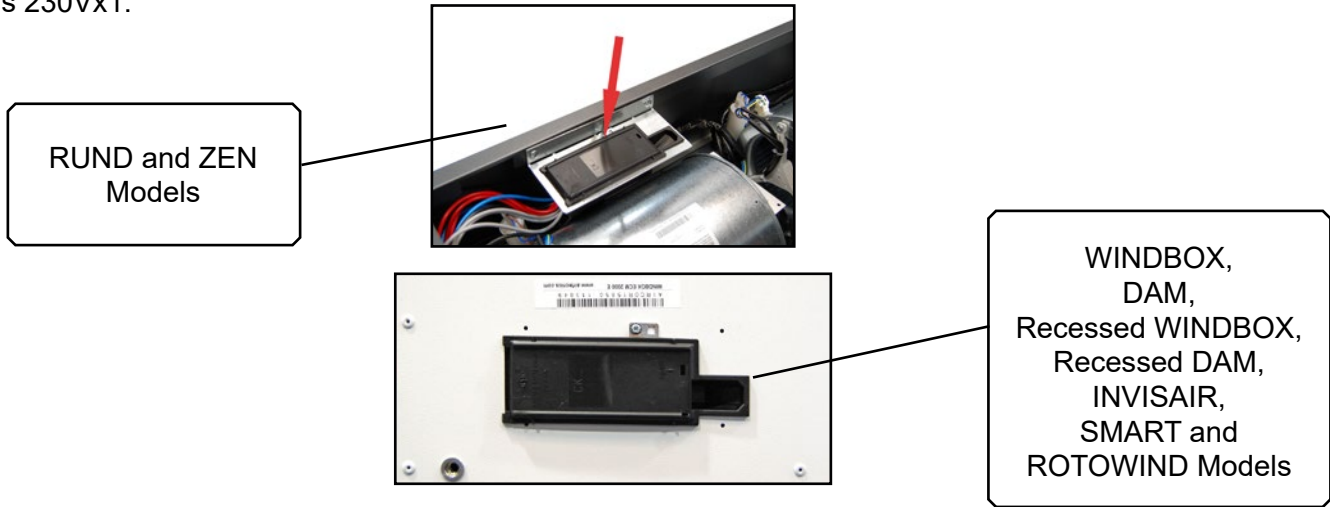

Only the single-phase 230V power supply is required to operate the fans.

The recommended maximum number of air curtains connected to the same differential is:

Model	Differential 30mA	Differential 300mA
ECM-ECG	2 uds.	20 uds.

Each installation must be checked by a specialist to verify that there is no incompatibility between the selected electrical protections and the connected air curtains.

Kit DX: Follow the instructions of the heat pump manufacturer to connect it.

Outdoor unit (condenser): Follow the instructions of each condenser unit to connect the power supply. The voltage can be of 230Vx1 or 400Vx3 depending on the model.

Condensate pump (applicable only in models with cool): It is the pump to empty the condensate tray and must be connected the air curtains PCB.

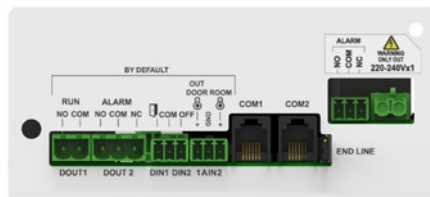

Control

To connect the control to the air curtain, there are terminals (COM1 or COM2) located on the outside top of the air curtain. It is not necessary to open the air curtain to connect it, except for internal connections. Use the 7 meter RJ11 cable supplied with the equipment and connect one side to the control and the other to COM1 or COM2 in the air curtain.



Airtècnics LCD Advanced PRO RJ11 Control:

All contacts must be free voltage.

- o *ON/OFF contact:* Connect the output FAN (“D03” and “D01”) of the DX-Kit to the terminals “DIN1” and “GND” of the control. When the contact is closed, the fans of the curtain turn on.

- o *Defrost (optional):* Connect the output Defrost (“D02” and “D01”) to the terminals “DIN2” and “GND” of the control. The unit is set to configurated speed (V1 default) for the duration of the defrost. The fan and ventilation speeds icons will flash intermittently.

Kit-DX: Controls the functioning of the external heat pump unit and it should be installed close to the air curtain. It sends orders and communicates with the air cuartain PCB and LCD Advanced PRO RJ11.

It must be configured in the LG’s PCB the power of the outdoor unit using the switch “4” and the resistors indicated in the following tables depending on the Air Curtain and Eprom.

1:1 System		
Capacity Adjustment		
Air Curtain	SW	Btu
DX8	OFF,ON,ON,ON	30k
DX10,11	ON,OFF,OFF,OFF	36k
DX15	ON,OFF,ON,OFF	48k
DX16	ON,OFF,ON,ON	60k
DX22	ON,ON,OFF,OFF	70k
DX27	ON,ON,OFF,ON	85k

VRF System		
Capacity Adjustment		
Air Curtain	SW	Btu
VRF8	OFF,ON,OFF,OFF	28k
VRF10,12	OFF,ON,OFF,ON	36k
VRF15	OFF,ON,ON,OFF	42k
VRF16,19	OFF,ON,ON,ON	48k
VRF20	ON,OFF,OFF,OFF	54k
VRF21,24 VRF25,26	ON,OFF,OFF,ON	76k
VRF29	ON,OFF,ON,OFF	96k
VRF34	ON,OFF,ON,ON	115k

Control: Connect to DX kit. The DX control decides the mode (air, heating and, in curtains prepared for that, in cooling) and the Set temperature. The air curtain only can work when the DX control is ON.

Outdoor unit: Connect it with the DX kit according to the wiring diagram.

Condensate water pump: Mandatory on cooling models. If not installed, it may result in water damage to the unit (not covered by the guarantee) or to the building. Airtècnics optionally provides a condensate pump with a hose cable of 3 pins for the power supply of the condensate pump.

Alarm: Connect Addon 230V (HP) “NC” and “C” of the air curtain PCB to the Kit INPUTS “UI13” and “G” of the DX Kit.

Fixings

The air curtain has several external fastening points depending on the weight and length (see situation in the model characteristics section).

Generally, air curtains are installed horizontally. The anchor must be sized according to the weights of each air curtain indicated on the technical data page. The installation can be done using threaded rods, tensioners or other supports (see available supports in the accessories section).

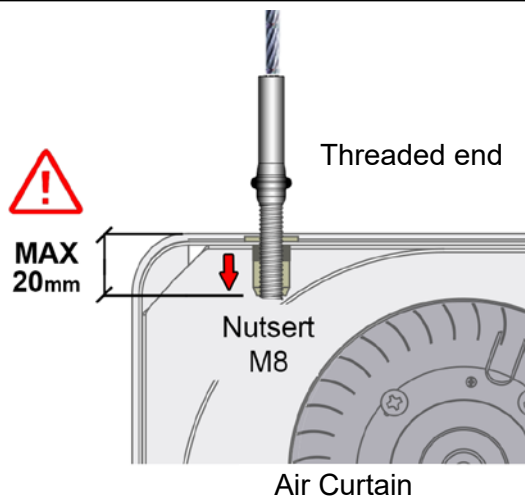

TRANSPORTATION AND STORAGE



Warning! Heavy load.

Do not stand under the suspended load during transportation or assembly.

Store in a dry place protected from the environment. If the package is opened, cover the air curtain to protect it from the dust. Do not step on or place heavy loads on it to avoid damage to the material. Storage temperature between -20 °C and +40 °C.

When transporting the material, be sure to use the recommended tools to move and lift heavy parts to prevent injuries or damages. Also you must ensure that it is not damaged by the forklift. (possible penetration of the fork in the packaging). Observe the instructions on the packaging for correct manipulation of the product.



OPERATING INSTRUCTIONS

LCD Control ADVANCED PRO

The **ADVANCED PRO** is a versatile Plug&Play air curtain control with communication via a standard 4-way RJ11 cable.

Compatible with all air curtain models:

- 2 and 5 ventilation speed

Once connected, it will detect the model of the air curtain and configure itself automatically (number of speeds).

- Backlight LCD display indicates fan speed, heating stage, set, ambient and outdoor temperatures (if an additional sensor is installed outside the building), door status, alarms and errors, and external signals (EXT).

- Inbuild room thermostat to turn ON/OFF or modulate the heating according to set temperature.

- Ready for the installation of a potential-free door contact. This can be used to set one speed and heating stage for open door and another for closed door.

- It has 3 digital inputs with different functions depending on the air curtain model connected (OFF outside, OFF heating, fire alarm, etc.).

- Maximum speed and heating settings for open door and closed door, boost mode, memory, etc.

Screen and Button Layout:

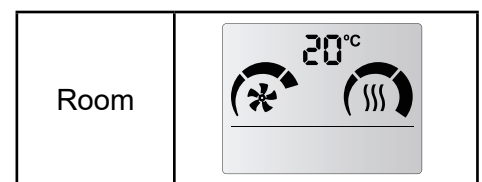
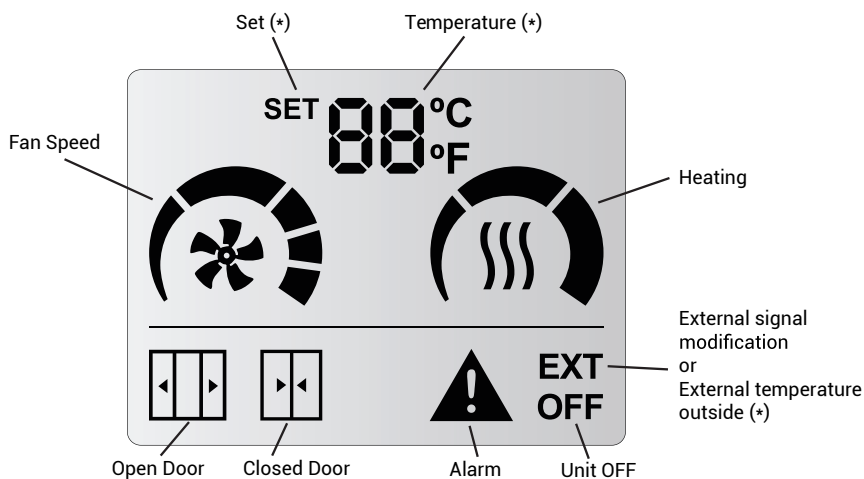

Button Layout:



- ON/OFF (circle with line) allows to return to previous screen in Menus and starts/stops the air curtain.

- Use the arrows to set the temperature when electrical/water.

- User Menu to configure:

- Door open and door close ventilation speed.

User Functioning:

The display will know what functional limits exists and will only show the parameters that the user can modify.

- **Fan Speed:** user can select one fan speed for open and another for closed door. If the speed is set to 0 then the unit will be off.

- **Slave DX (P2):** Only one speed can be selected when the heat pump is running.

Device Initialization

When the control is powered, the display will show the firmware version and subversion, the input/output program it is working on is always P2 for Heat Pump.

Example: Displays show with a V01.02 version, a P2 configuration of inputs/outputs and 2 PCBs connected.

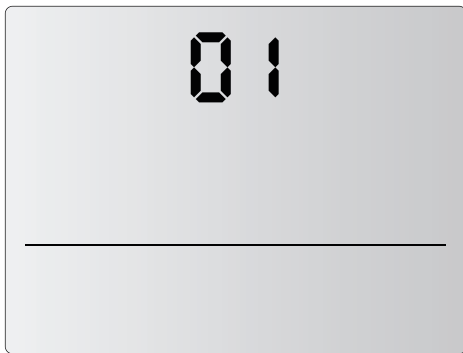

ADVANCED PRO version: 01

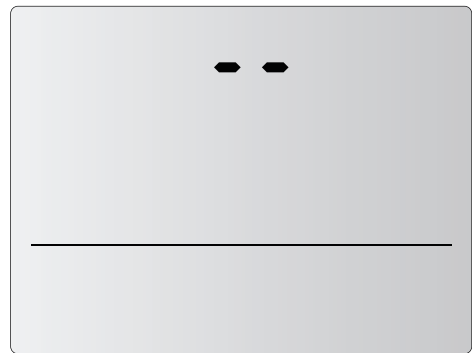

Space between version and subversion.

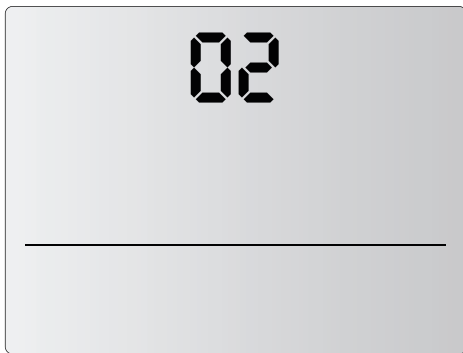

ADVANCED PRO subversion: 02

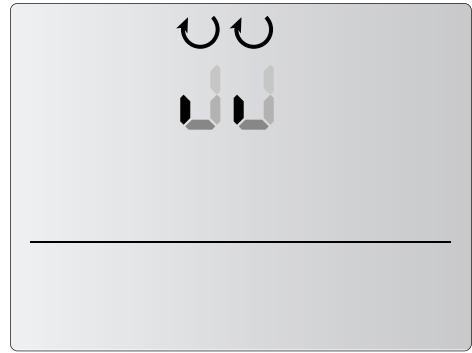
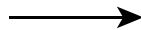

Scanning units.

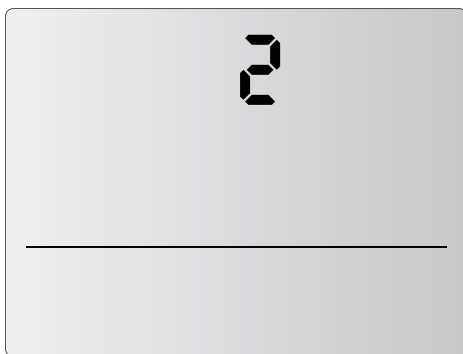

2 units connected to the control
(last number shown during initialization)

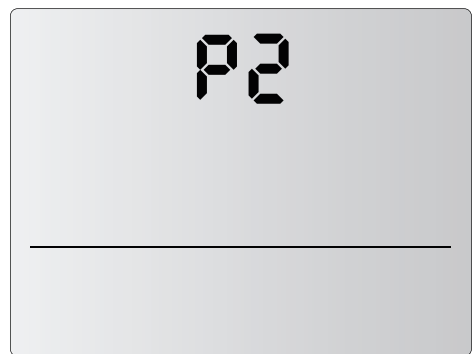
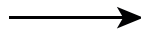

Unit Working in P2.

Digital Input:
DIN1 - FAN
DIN2 - Defrost
DIN3 - Fire Alarm

LCD User Menu Flow

Once the control has been initialised, the user can select the ventilation speeds at which the air curtain is wanted to operate. To do this, the user may follow the diagram below:

Menu flow for heat pump air curtains and P2 configuration on the LCD:

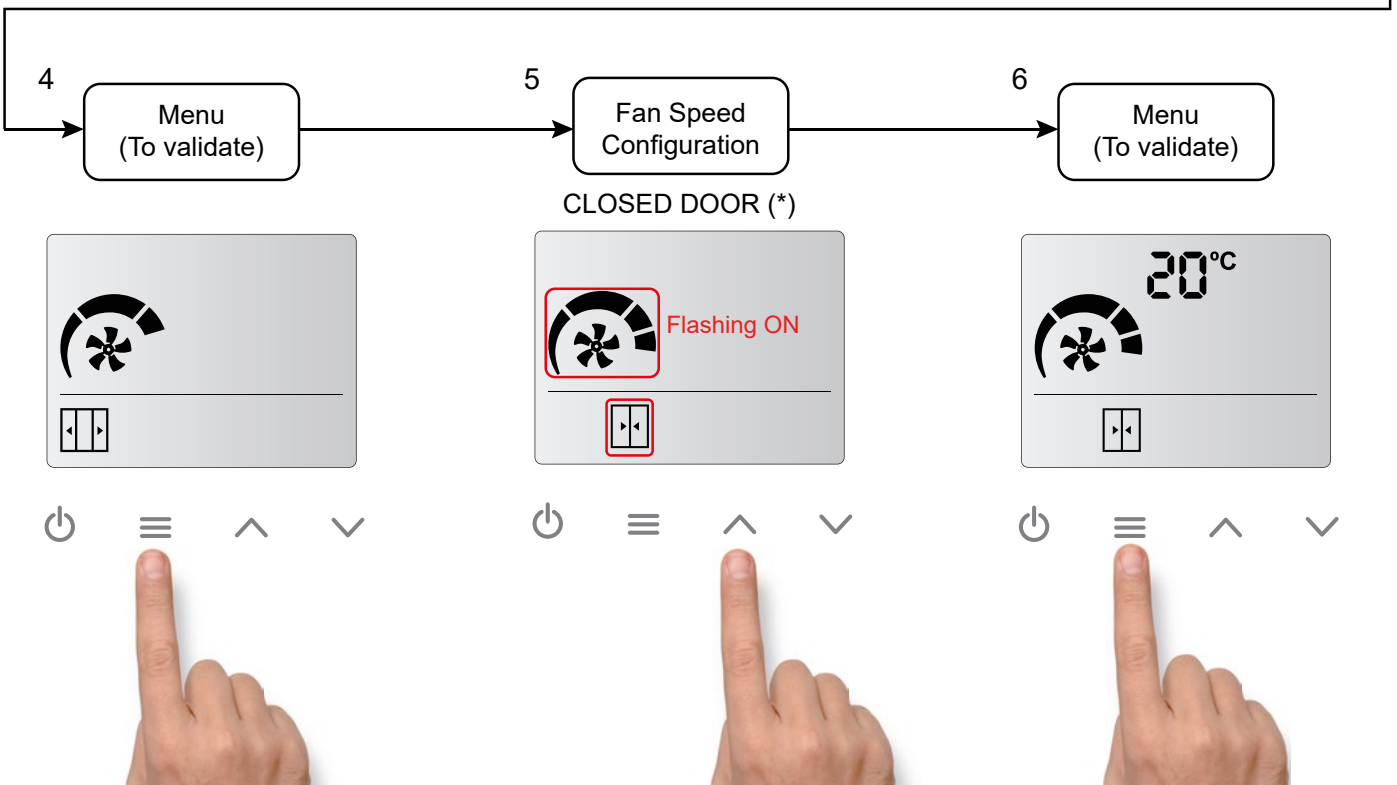
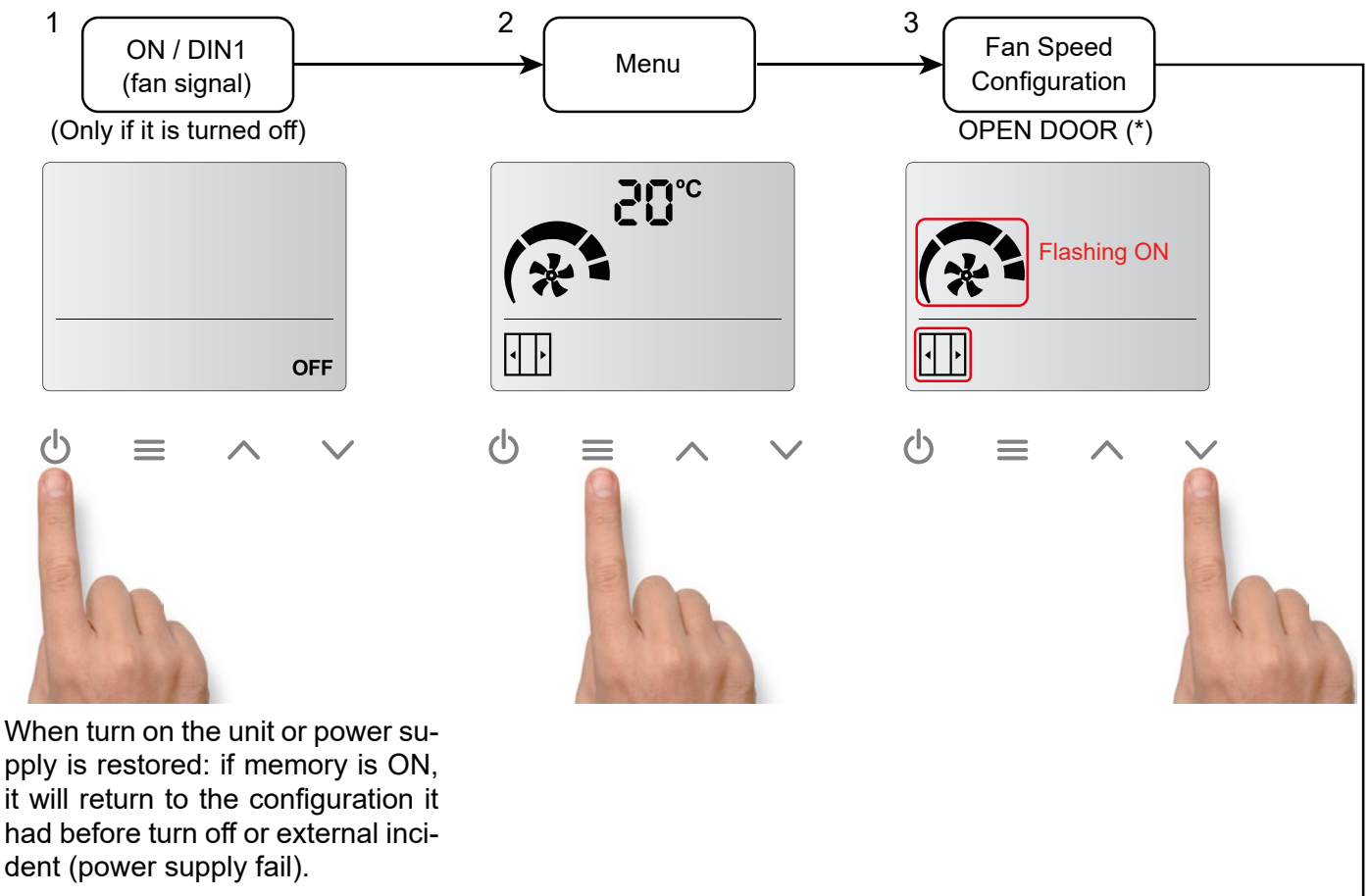

(*) If the door contact is not detected, the door open and door closed icons will not appear. Only one speed and one heating will be available.

For the door icons to appear, a door contact must be connected to the 'PCB DIN1' input and a door opening and closing cycle must be performed.

Control Locking

The control can be locked, but the air curtain will still operate normally.
To lock the device, the user needs to press the following key combination:

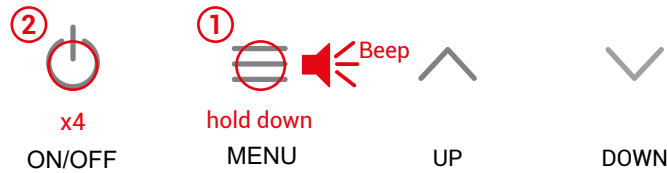

Hold down the menu button until the beep sounds and press the ON/OFF button 4 times and release the MENU button. Then a higher-pitched beeping sound will be played.

When the equipment is locked, the user will not be able to carry out any action. This limitation also applies with the remote control.

For example, when pressing the menu, a lower-pitched beep will be played indicating that the equipment is locked.

In addition, the alarm symbol shall appear on the display.

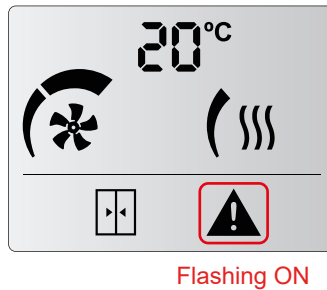

To **unlock the unit**, the user must repeat the same combination of buttons as for locking.
Then a higher-pitched beeping sound will be played, indicating that the control has been unlocked.

Factory Reset

The factory configuration reset function returns to the default values of the configuration menu, to do so:
Hold down the MENU button until the beep sounds, press alternitavely 4 times the UP and DOWN buttons, 2 times for each. The icon Fc will appear on screen.

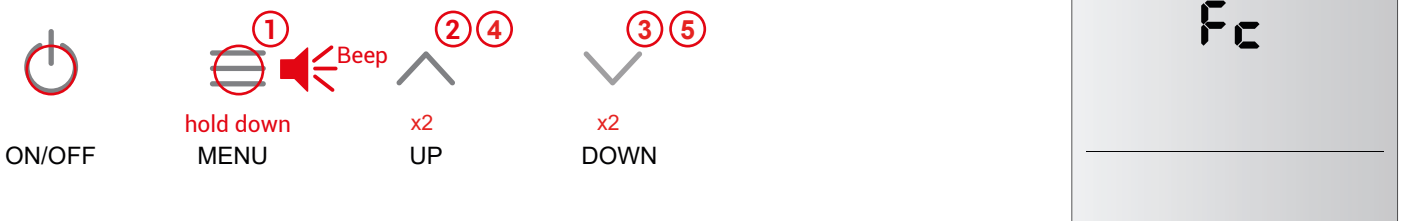



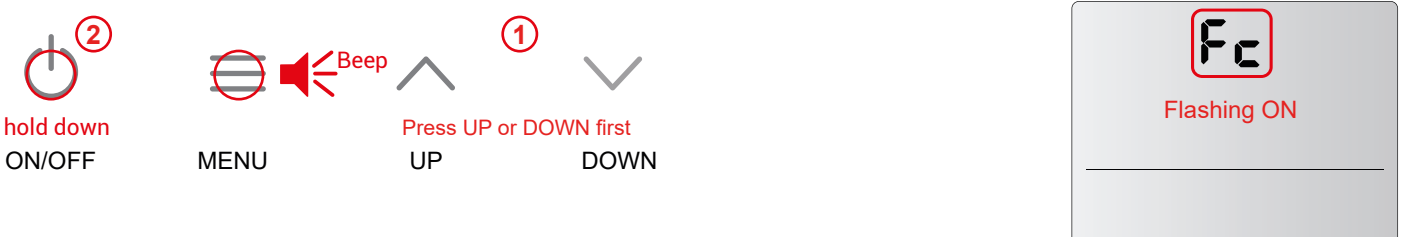



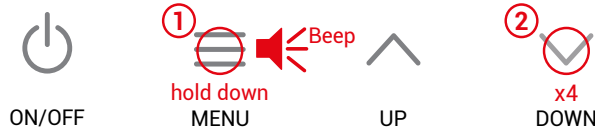

Press either the UP or the DOWN button, the Fc icon will flash on. Afterwards, hold down the ON/OFF icon for 3 seconds and you will hear 3 beep sounds to finally return to the factory configuration.



Advanced Configuration

To access the advanced menu, hold down the menu button (until a beep is heard) then press the DOWN button 4 times and release the MENU button.



1- Door Delay (0,5,10...90)(seconds) 15 sec by default	2- Maximum speed (limit) Open Door (*)	3- Maximum speed (limit) Closed Door (*)	4- Filter/maintenance (effective days) (*) (0,1,2....99) (0 days by default)
<div style="font-size: 24px; font-weight: bold;">20</div> <p style="font-size: 10px; color: red;">Flashing ON alternating open/closed</p> 	<div style="font-size: 24px; font-weight: bold;">02</div> <p style="font-size: 10px; color: red;">Flashing ON</p> 	<div style="font-size: 24px; font-weight: bold;">01</div> <p style="font-size: 10px; color: red;">Flashing ON</p> 	<div style="font-size: 24px; font-weight: bold;">92</div> <p style="font-size: 10px; color: red;">Flashing ON</p> 
5- Celsius/Fahrenheit Celsius by default	6- Memory 00 - Memory OFF 01 - Memory ON (by default)	7- Defrost Function Only for Heat Pump air curtains	Press Button Between screens
<div style="font-size: 18px; border: 1px solid red; padding: 2px;">°C</div> <p style="font-size: 10px; color: red;">Flashing ON</p>	<div style="font-size: 24px; font-weight: bold; border: 1px solid red; padding: 2px;">00</div> <p style="font-size: 10px; color: red;">Flashing ON</p> <p style="font-size: 10px;">OFF</p>	<div style="font-size: 24px; font-weight: bold;">df</div> <p style="font-size: 10px; color: red;">Flashing ON</p> 	 

1 - Time that the speed and heating stages remain in open door mode from the time the door contact is closed until the air curtain operates at closed door speed and heating stages.

2,3 - Limits the ventilation stages that can be selected in the user menu.

4 - The numbers are sequential. If the maximum is reached, it will go back to the beginning. For example, in the *Filter/maintenance* days when the user reach 99 in case to keep going up it will go back to 0.

6 - In a power failiure:



- If Memory is set as ON. Once power supply is restored, the unit will go back to work with the same parameters than before the failure.

- If Memory is set as OFF. The unit will remain switched off.

(*) By default, door open/close icons are not activated. First time the door contact is closed, then it is possible to choose door open heating/ventilation and door closed heating/ventilation.

7 - Choose the desired maximum speed when defrost is active.

Temperature sensors in the air curtain

	<p>If some welding is made in the pipes of the air curtains coil, the sensors can be damaged, causing operating errors. If some welding must be done, avoid that the heat reaches the air curtain sensors.</p>
	<p>All consequential damages, direct and indirect, due to wrong installation of the air curtain are excluded from the guarantee.</p>

- **High pressure sensor (liquid)**



High pressure sensor (liquid, PIPEIn)
Black - EBG611287704

- **Low pressure sensor (gas)**

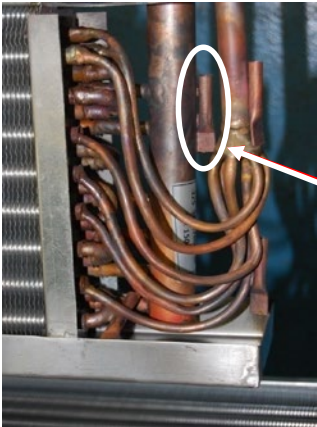

Low pressure sensor (gas, PIPEOut)
Red - EBG611287703

The liquid and gas sensor will be placed on the supports shown on the previous images.

- **Room sensor**

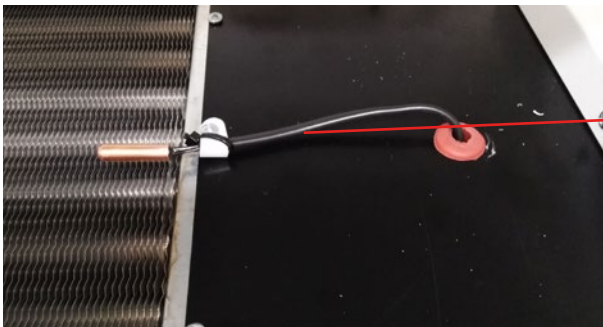

Room Sensor (inlet)
Black - EBG61106821

The flange and cable hole are installed in the inlet air curtain zone. If we want to access to the sensor, we should remove the inlet grill (see repairs section of this manual).

Once all sensors are installed, proceed with the insulation to avoid the sensors contact with the air. For the insulation use thermal insulating foam, insulating tape, etc.

Find an example in the following picture of how to insulate the sensors:



AIR CURTAINS WORKING MODE



Air curtains which are not prepared to work in cooling **MUST NEVER** start the cooling mode. In case they started to work in cooling mode, the condensation in the coil could reach the electronic components and cause water droplets through the outlet and the service door of the air curtain, losing all guarantee.

If the air curtain is ONLY HEATING, it cannot be integrated into a centralized control if the mode change cannot be locked.

Airtècnics does not recommend air curtains to work with cool, because the air speed must be limited to try to avoid the dragging condensates. Due to this limitation, the air curtain doesn't perform the air barrier function as it should be.

WINDBOX M,G DX-LG

HEAT PUMP ENERGY SAVING AIR CURTAINS FOR LG OUTDOOR UNITS (1:1)



Technical Features





Range
Up to 4,2 m

Heating types
Heat Pump
Gas R32 / R410a

Casing
Galvanised Steel
Self-Supporting



Airflow / Length
1640 - 5840 m³/h
1m to 3m

Heating capacity
7,9 - 27 kW

Grille type
Micro-perforated with
pre-filter included

Fans
Centrifugal
5-speed

Control
Plug&Play Advanced PRO
+ IR remote control
(Optional Clever Pro)

Outlet vanes
Aluminium, airfoil type
Adjustable 0-15° each side

RAL 9016 standard  Stainless steel  Other colors on request 

WINDBOX air curtains range provide equipment suitable for all types of commercial entrances. A compact and robust air curtain from our standard range with a timeless design, ready for visible installation over the door and prepared for multiple false ceiling installation configurations. In heating, it reduces consumption and CO2 emissions by up to 70%.

Prepared to connect to LG Inverter heat pump (R32/R410) with direct expansion valve, not included, to be purchased by the customer.

Sensors pre-installed in the direct expansion coil. As an option, under request, it can also work in cold mode (refrigeration), with optional condensate water pump. Efficient EC centrifugal fans with low consumption, double inlet with external rotor motor and low noise level. Internal pre-filter included.

Advanced Plug&Play control. Includes: Advanced PRO control with LCD display and integrated thermostat, door contact, 7m RJ11 cable and remote control.

Includes DX Interface Kit PAHCMRA000 adapted for the air curtain, and LG PREMTB001 programmable control.

AIR CURTAIN SPECIFICATIONS

Model	Airflow	Ventilation power 230V-50/60Hz	Ventilation current 230V-50/60Hz	Outdoor unit (*)	Outdoor unit (*)	Pipes gas-liquid	Noise level (5 m)	Weight kg
	m ³ /h	kW	A	230Vx1	400Vx3	inch	dB(A)	
ECM 1000 DX8-LG	1640	0,142	1,24	UUC1 U40	-	5/8" - 3/8"	56	35
ECM 1500 DX11-LG	2460	0,213	1,86	UUD1 U30	UUD3 U30	5/8" - 3/8"	57	53
ECM 2000 DX16-LG	3280	0,284	2,48	UUD1 U30	UUD3 U30	5/8" - 3/8"	58	69
ECM 2500 DX22-LG	4100	0,355	3,10	-	UU70W U34	1"1/8 - 3/8"	59	86
ECM 3000 DX27-LG	4920	0,426	3,72	-	UU85W U74	7/8" - 1/2"	60	103
ECG 1000 DX10-LG	2190	0,213	1,86	UUD1 U30	UUD3 U30	5/8" - 3/8"	61	50
ECG 1500 DX15-LG	2920	0,284	2,48	UUD1 U30	UUD3 U30	5/8" - 3/8"	62	59
ECG 2000 DX20-LG	4380	0,426	3,72	-	UU70W U34	1"1/8 - 3/8"	63	92
ECG 2000 DX22-LG	4380	0,426	3,72	-	UU70W U34	1"1/8 - 3/8"	63	92
ECG 2500 DX22-LG	5110	0,497	4,34	-	UU70W U34	1"1/8 - 3/8"	64	96
ECG 2500 DX27-LG	5110	0,497	4,34	-	UU85W U74	7/8" - 1/2"	64	96
ECG 3000 DX27-LG	5840	0,568	4,96	-	UU85W U74	7/8" - 1/2"	65	109

(*) Includes direct expansion valve.

OUTDOOR UNIT SPECIFICATIONS

LG Inverter outdoor unit model	Heating capacity	COP or SCOP	Cooling capacity	EER or SEER	Power supply	Pipes gas-liquid	Pipes minimum - maximum length	Pipes maximum height
	kW		kW			inch	m	m
UUC1 U40	7,9	4,8	6,8	8,5	230Vx1	5/8" - 3/8"	5 - 50	30
UUD1 U30 (36)	10,8	4,5	9,5	7,6	230Vx1	5/8" - 3/8"	5 - 85	30
UUD1 U30 (42)	13,5	4,5	12,1	7,4	230Vx1	5/8" - 3/8"	5 - 85	30
UUD1 U30 (48)	15,5	4,5	13,4	6,8	230Vx1	5/8" - 3/8"	5 - 85	30
UUD1 U30 (60)	17,5	4,5	15	6,6	230Vx1	5/8" - 3/8"	5 - 85	30
UUD3 U30 (36)	10,8	4,5	9,5	7,6	400Vx3	5/8" - 3/8"	5 - 85	30
UUD3 U30 (42)	13,5	4,5	12,1	7,4	400Vx3	5/8" - 3/8"	5 - 85	30
UUD3 U30 (48)	15,5	4,5	13,4	6,8	400Vx3	5/8" - 3/8"	5 - 85	30
UUD3 U30 (60)	17,5	4,5	15	6,6	400Vx3	5/8" - 3/8"	5 - 85	30
UU70W U34	22,4	3,5	19	2,84	400Vx3	1"1/8 - 3/8"	5 - 75	30
UU85W U74	27	3,25	23	2,81	400Vx3	7/8" - 1/2"	5 - 75	30

Energy efficiency: SCOP/SEER seasonal ≤12kW, COP/EER >12kW.

Outdoor unit capacities depending on standard conditions: heating 20°CDB indoor / 7°CDB and 6°CWB outdoor, cooling 27°CDB and 19°CWB indoor / 35°CDB outdoor. When adverse weather conditions, the outdoor unit capacity can decrease. It is recommendable to oversize the units.



Technical Features



RAL 9016 standard  Stainless steel  Other colors on request 



Range
Up to 4,2 m

Heating types
Heat Pump
Gas R32 / R410a



Casing
Galvanised Steel
Self-Supporting



Airflow / Length
1640 - 5840 m³/h
1m to 3m

Heating capacity
8 - 34 kW

Grille type
Micro-perforated with
pre-filter included

Fans
Centrifugal
5-speed

Control
Plug&Play Advanced PRO
+ IR remote control
(Optional Clever Pro)

Outlet vanes
Aluminium, airfoil type
Adjustable 0-15° each side

WINDBOX air curtains range provide equipment suitable for all types of commercial entrances. A compact and robust air curtain from our standard range with a timeless design, ready for visible installation over the door and prepared for multiple false ceiling installation configurations.

In heating, it reduces consumption and CO2 emissions by up to 70%.

Prepared to connect to LG VRF outdoor heat pump unit (R32/R410) with direct expansion valve, not included, to be purchased by the customer.

Sensors pre-installed in the direct expansion coil. As an option, under request, it can also work in cold mode (refrigeration), with optional condensate water pump. Efficient EC centrifugal fans with low consumption, double inlet with external rotor motor and low noise level. Internal pre-filter included.

Advanced Plug&Play control. Includes: Advanced PRO control with LCD display and integrated thermostat, door contact, 7m RJ11 cable and remote control.

Requires LG VRF Interface KIT adapted for air curtain, expansion valve and programmable control, please consult.

AIR CURTAIN SPECIFICATIONS

Model	Airflow m ³ /h	Ventilation power	Ventilation current	Expansion valve	Pipes gas-liquid	Noise level (5 m)	Weight kg
		230V-50/60Hz kW	230V-50/60Hz A		inch	dB(A)	
ECM 1000 VRF8-LG	1640	0,142	1,24	PRLK048A0	5/8" - 3/8"	56	35
ECM 1500 VRF12-LG	2460	0,213	1,86	PRLK048A0	5/8" - 3/8"	57	53
ECM 2000 VRF16-LG	3280	0,284	2,48	PRLK048A0	5/8" - 3/8"	58	69
ECM 2000 VRF19-LG	3280	0,284	2,48	PRLK048A0	5/8" - 3/8"	58	69
ECM 2500 VRF21-LG	4100	0,355	3,10	PRLK048A0	1"1/8 - 3/8"	59	86
ECM 2500 VRF24-LG	4100	0,355	3,10	PRLK048A0	1"1/8 - 3/8"	59	86
ECM 3000 VRF26-LG	4920	0,426	3,72	PRLK048A0	7/8" - 1/2"	60	103
ECG 1000 VRF10-LG	2190	0,213	1,86	PRLK048A0	5/8" - 3/8"	61	50
ECG 1500 VRF15-LG	2920	0,284	2,48	PRLK048A0	5/8" - 3/8"	62	59
ECG 2000 VRF20-LG	4380	0,426	3,72	PRLK048A0	1"1/8 - 3/8"	63	92
ECG 2000 VRF24-LG	4380	0,426	3,72	PRLK048A0	1"1/8 - 3/8"	63	92
ECG 2500 VRF25-LG	5110	0,497	4,34	PRLK048A0	1"1/8 - 3/8"	64	96
ECG 2500 VRF29-LG	5110	0,497	4,34	PRLK048A0	7/8" - 1/2"	64	96
ECG 3000 VRF29-LG	5840	0,568	4,96	PRLK048A0	7/8" - 1/2"	65	109
ECG 3000 VRF34-LG	5840	0,568	4,96	PRLK096A0	7/8" - 1/2"	65	109

When adverse weather conditions, the outdoor unit capacity can decrease. It is recommendable to oversize the units.

VRF-compatible models are as follows:

- Multi V S
- Multi V 5
- Multi V IV



Selection program



Dimensions

Horizontal free hanging Installation

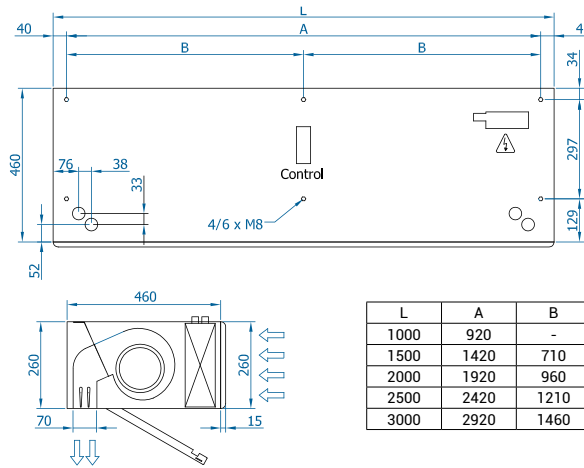

Inside ceiling surface mounting

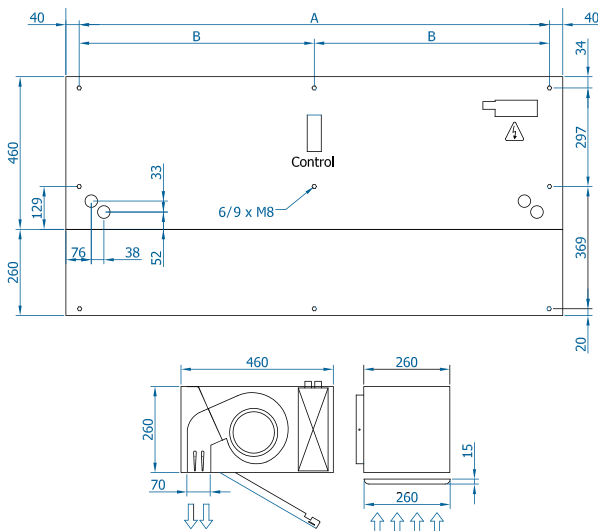

False ceiling invisible mounting

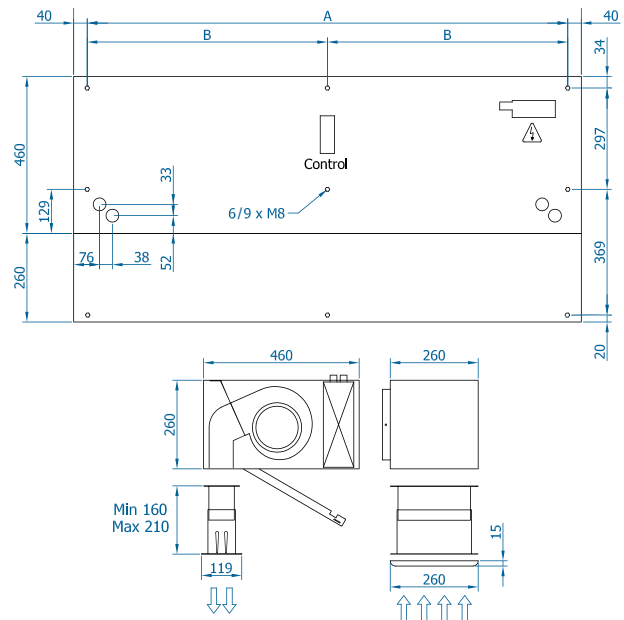

CAD drawings, BIM files, installation manuals and other documents





Installation configurations

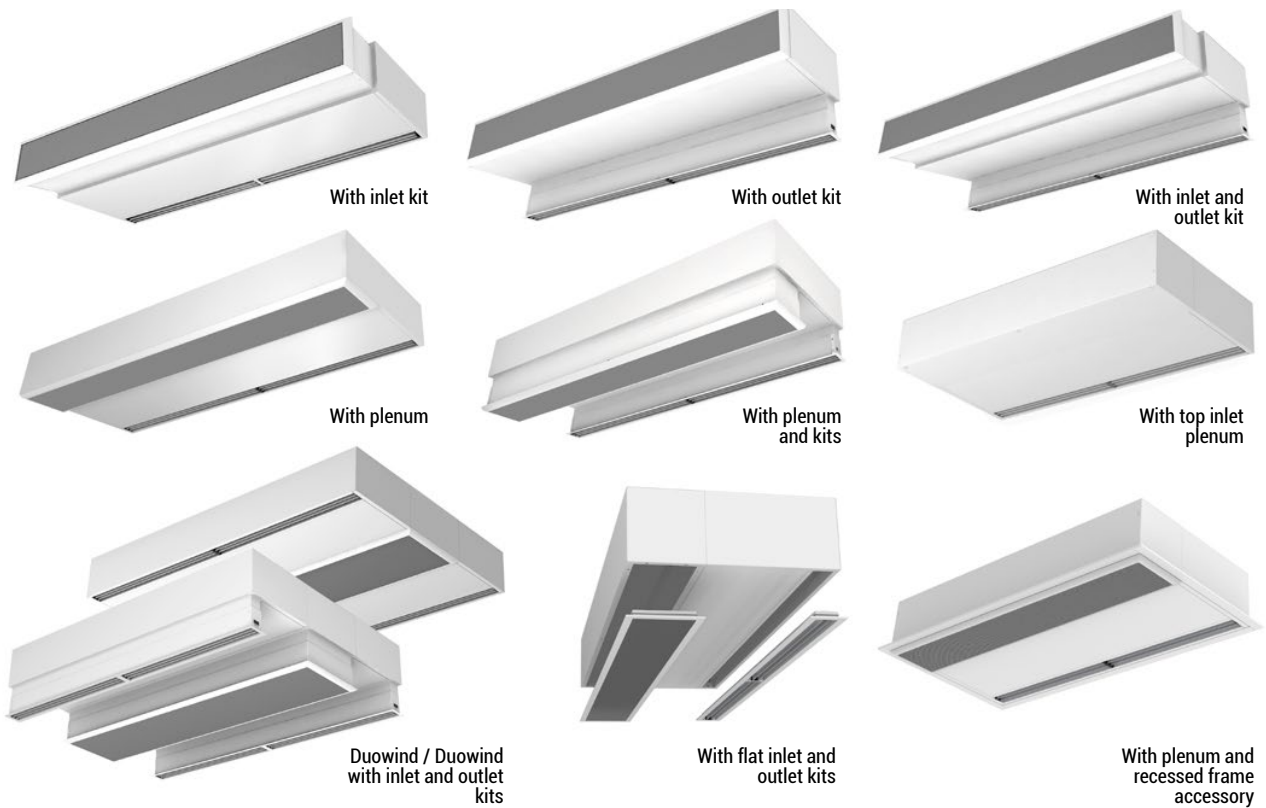

Accessories

Supports and installation



Wall rail support
SPWR



Silentblock supports
SPANG-SIL / SLB



Gripple hanger
SPCT

Control



ADVANCED PRO
✓ Included



IR Control
✓ Included



RJ11 Cable
✓ Included



CLEVER PRO

Sensors and valves



Magnetic door contact
DC
✓ Included



Mechanical door contact
DC



Condensate water pump
for DX air curtains

RECESSED WINDBOX DX/VRF-LG

ENERGY SAVING AIR CURTAINS FOR LG HEAT PUMPS (1:1/VRF)



Dimensions

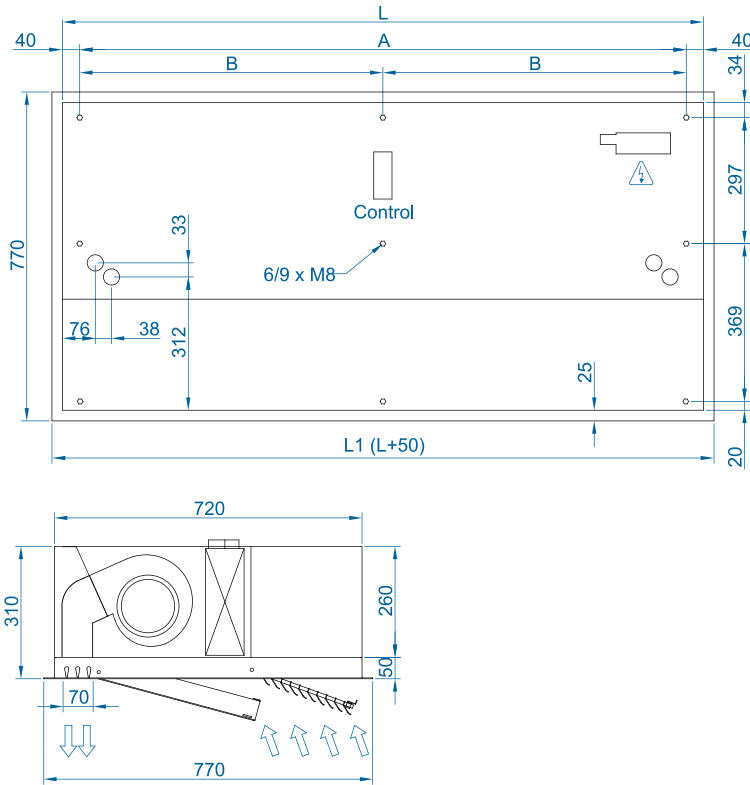

Model	L	L1	A	B
1000	1000	1050	920	-
1500	1500	1550	1420	710
2000	2000	2050	1920	960
2500	2500	2550	2420	1210

CAD drawings, BIM files, installation manuals and other documents



DAM DX/VRF-LG

ENERGY SAVING AIR CURTAINS FOR LG HEAT PUMPS (1:1/VRF)



Dimensions

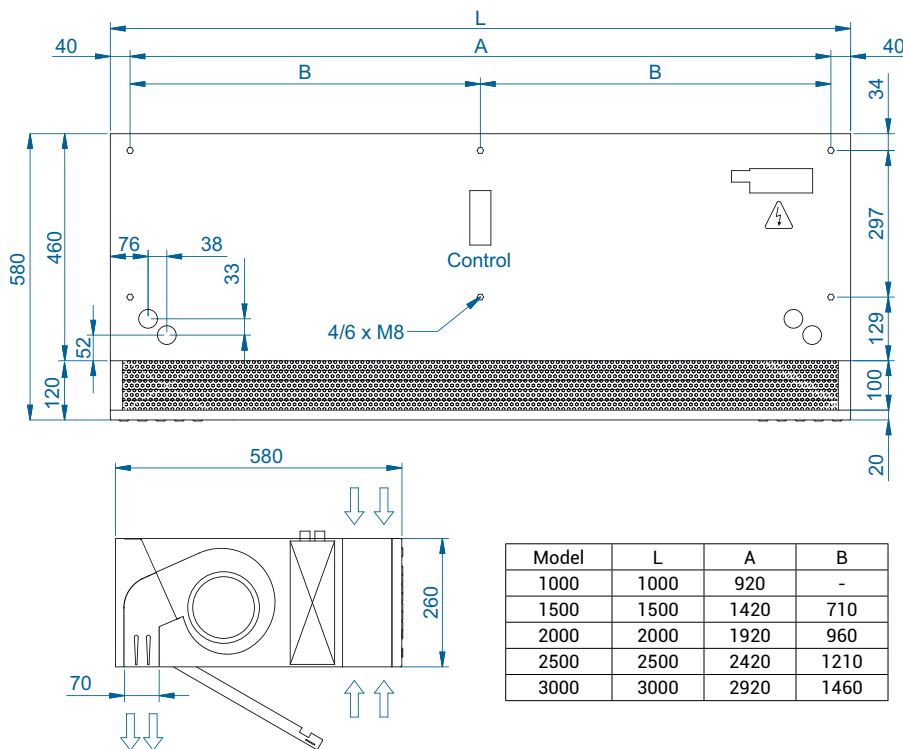

Model	L	A	B
1000	1000	920	-
1500	1500	1420	710
2000	2000	1920	960
2500	2500	2420	1210
3000	3000	2920	1460

CAD drawings, BIM files, installation manuals and other documents





Dimensions

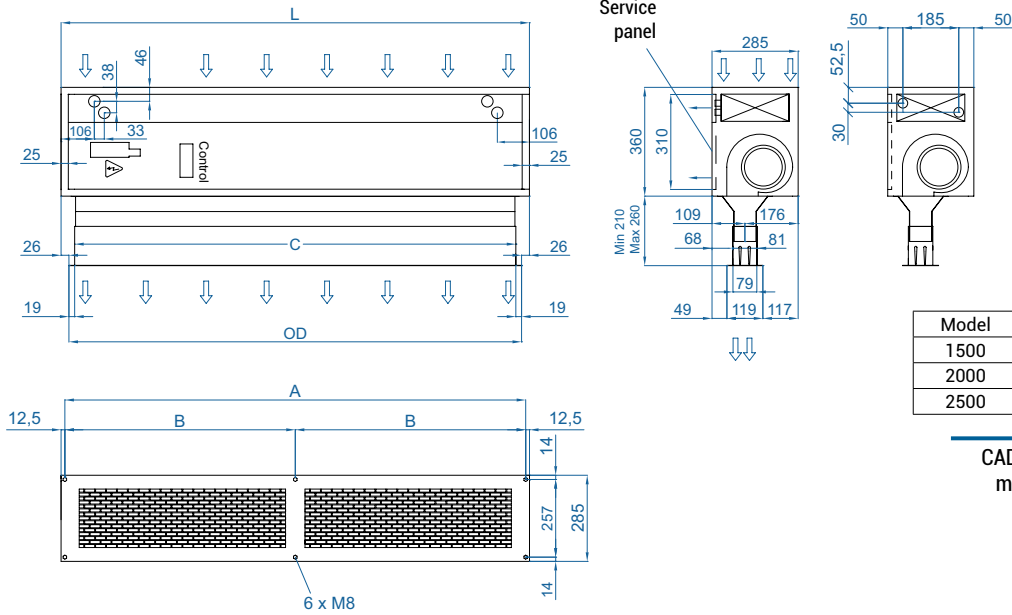

Dimensions

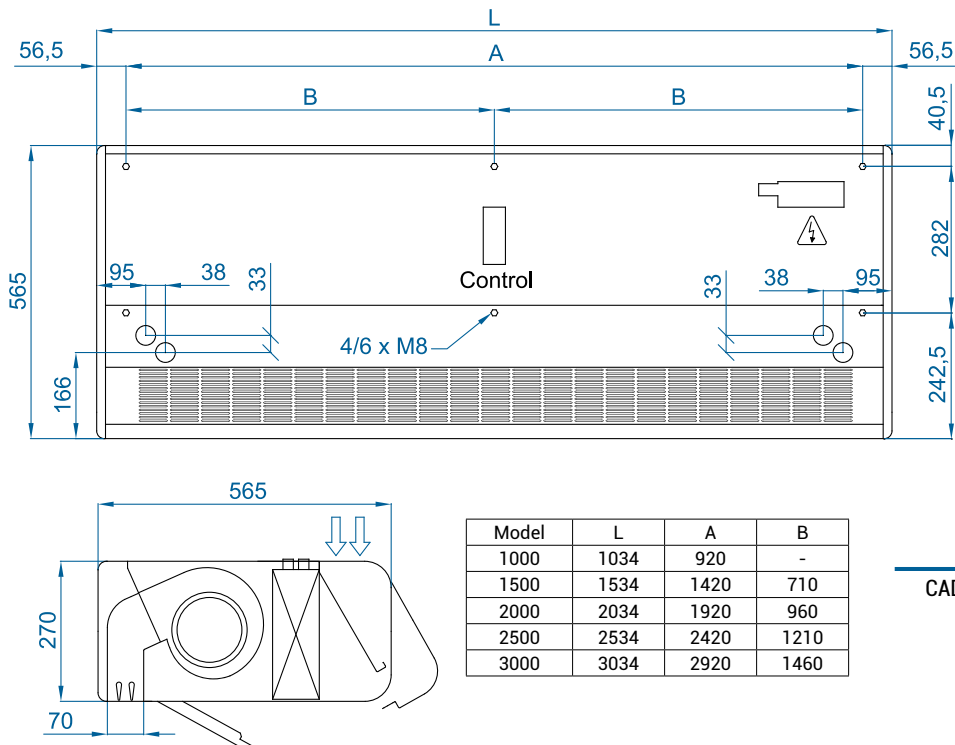



Dimensions

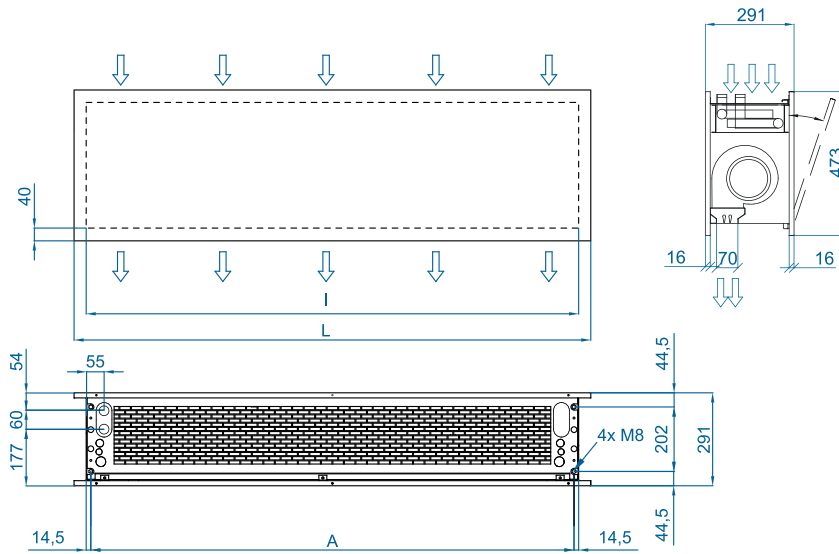

Model	E	I	A
1000	1220	1140	1115
1500	1620	1544	1515
2000	2120	2044	2015
2500	2620	2544	2515

CAD drawings, BIM files, installation manuals and other documentation



Finishings

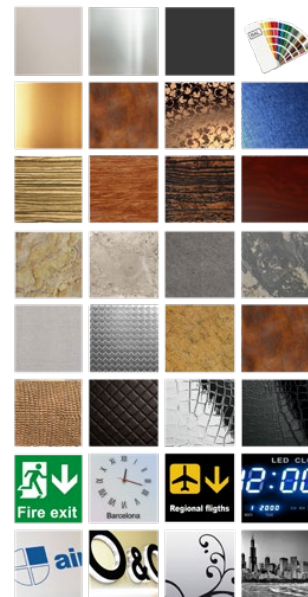

standard /
painted

decorative
metals

wood

stone

industrial

leather

signage

logos /
images



Vertical installation





Dimensions

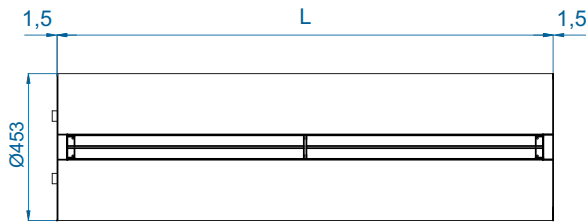

Model	L
1000	1025
1500	1525
2000	2030
2500	2530
3000	2980

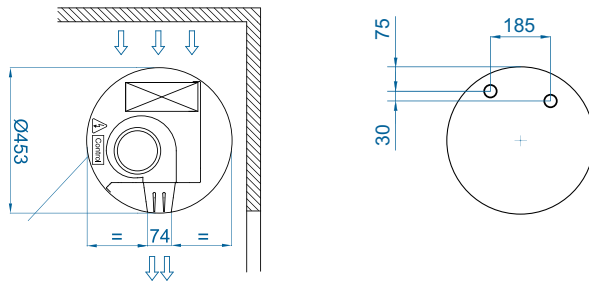

CAD drawings, BIM files, installation manuals and other documentation



Configurations and supports



Ceiling fixation through threaded rods



Wall/ceiling fixation through arms



Wall/ceiling fixation through angle supports



Wall fixation through lateral arms



Floor fixation (goalpost)



Dimensions

Standard: Installation above the door



Inverted: False ceiling installation

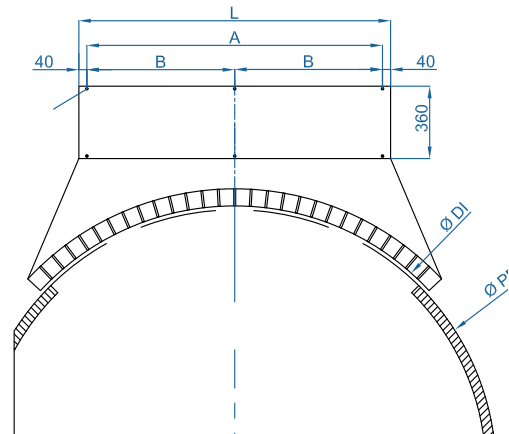
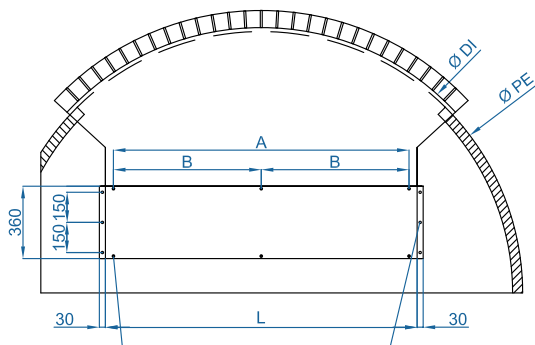
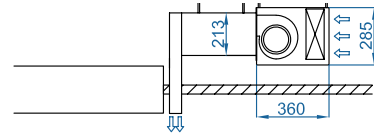
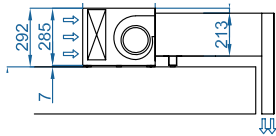
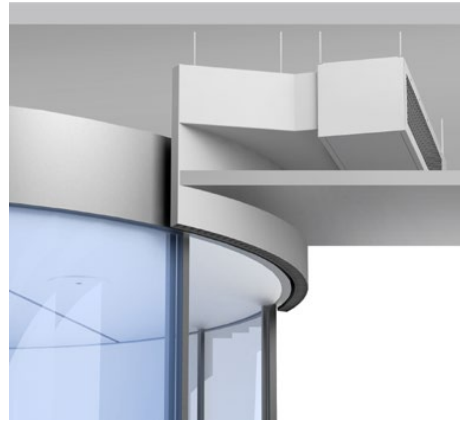





Model	L
1000	1050
1500	1550
2000	2055
2500	2555

ØDI	Inside outlet diameter
ØPE	External door diameter

CAD drawings, BIM files, installation manuals and other documentation



MAINTENANCE INSTRUCTIONS

	For safety, before cleaning, stop the air curtain through the control and wait 10 minutes before disconnect the device from the current.
 	Do not open the service door (risk of electric shock and entrapment in the fans). Repairs must be carried out exclusively by authorized personnel.
	The inside of the device must not be cleaned with water or steam.
	For manipulation safety, being it assembling, transport or maintenance it's a must to wear the correct individual protection equipment recommended. Those being gloves, insulating shoes, goggles and helmet.

Indicative periodicity of maintenance

N° Action	Action	Frequency
1	Filter cleaning	Bimonthly (recommended monthly)
2	Suction grille cleaning	Bimonthly (recommended monthly)
3	Exterior cleaning	Semiannual (recommended quarterly)
4	Interior cleaning	Semiannual (recommended quarterly)
5	Internal components visual inspection	Biannual (recommended annual)
6	Consumption and auditory control checking	Biannual (recommended annual)

Filter cleaning

The particle filter of the air curtain protects the coil from dirt and foreign elements that may clog it, causing a high efficiency performance reduction. On the following pages you will find the instructions for removing the filter for maintenance according to the standard air curtain model (Windbox) or Zen model. *For other models a separate instruction is attached.*

Windbox model includes a micro-perforated grille which has pre-filter functions, additional to the filter installed before the DX coil. The suction grille must be removed before cleaning the filter. These can be cleaned using a Hoover with a brush in order to not damage the filter. It is advisable to carry out this maintenance periodically to achieve the best efficiency of the equipment.

STANDARD AIR CURTAIN - Filter Installation

1 - Place and fasten the filters to the air curtain, using clamps:



Use
safety gloves

In the case of air curtains without plenum, the filters come already pre-installed inside the air curtain.

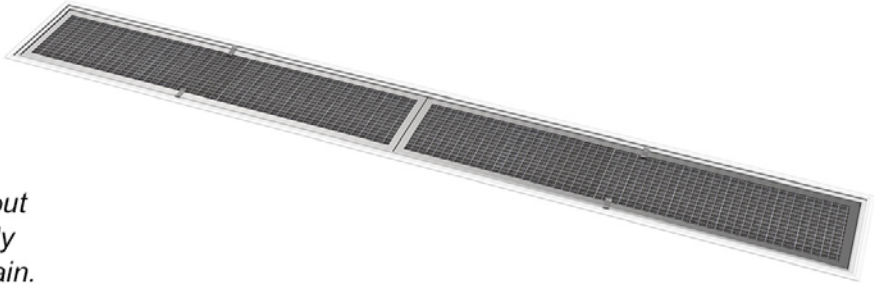

The clamps should be placed asymmetrically in the middle to make it easier to insert and remove the filter.

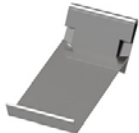
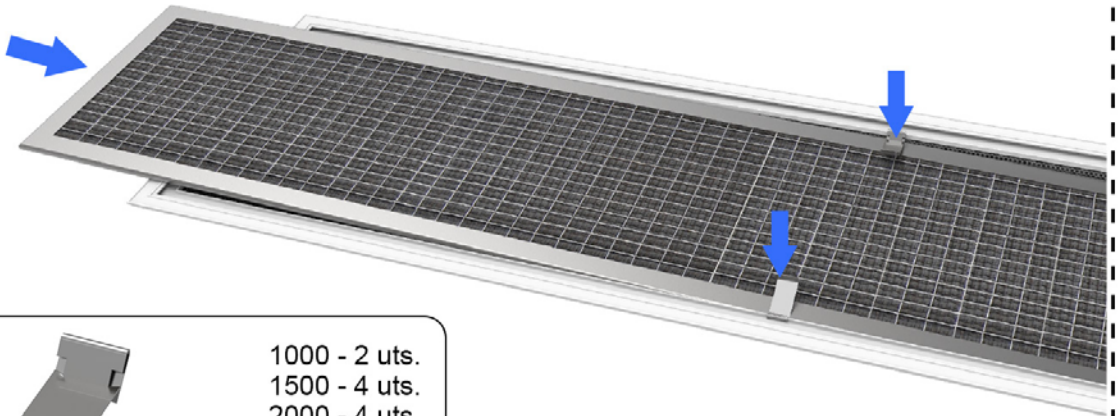

Clamp

1000 - 2 uts.
1500 - 4 uts.
2000 - 4 uts.
2500 - 6 uts.
3000 - 6 uts.

2 - Inlet grille fixing, inserting their pivots inside the air curtain clip holes.

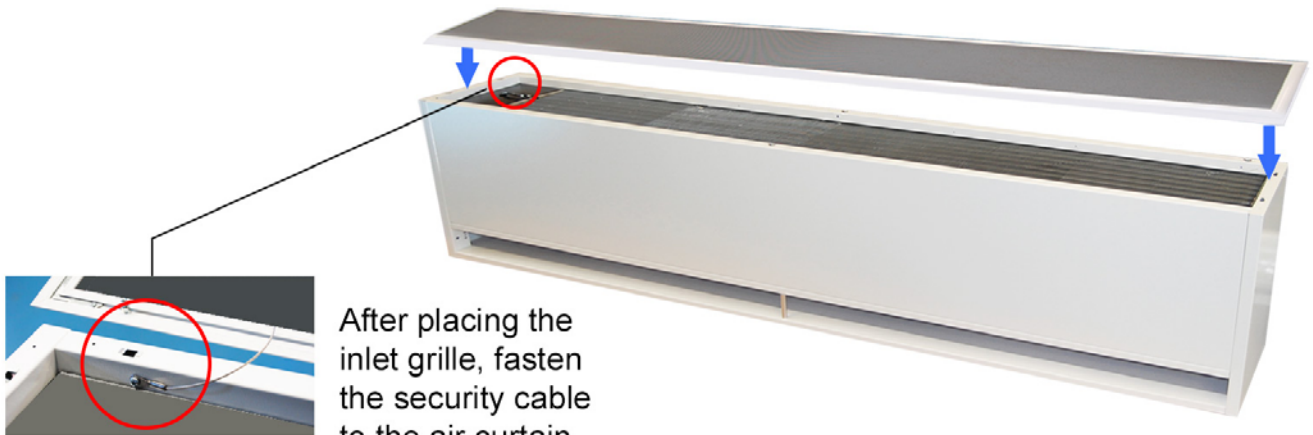

After placing the inlet grille, fasten the security cable to the air curtain

AIR CURTAIN WITH INLET PLENUM - Plenum and filter assembly process

1 - Assemble the plenum in the air curtain, using the indicated holes:



Use
safety gloves



	1000 - 8 pcs.
	1500 - 10 pcs.
	2000 - 13 pcs.
DIN 7504N	2500 - 13 pcs.
Philips 3,5 x 9,5	3000 - 14 pcs.

2 - Place and fasten the filters to the air curtain, using clamps:



(Same clamps assembly
sequence than "Standad Air Curtain")

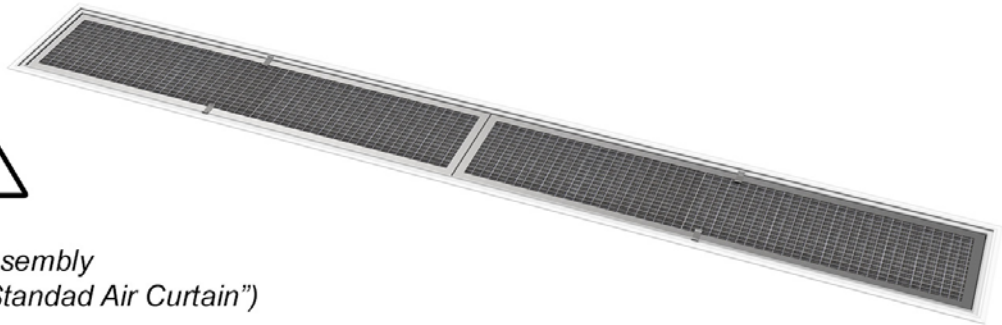

3 - Inlet grille fixing, inserting their pivots inside the air curtain clip holes.



After placing the
inlet grille, fasten
the security cable
to the air curtain

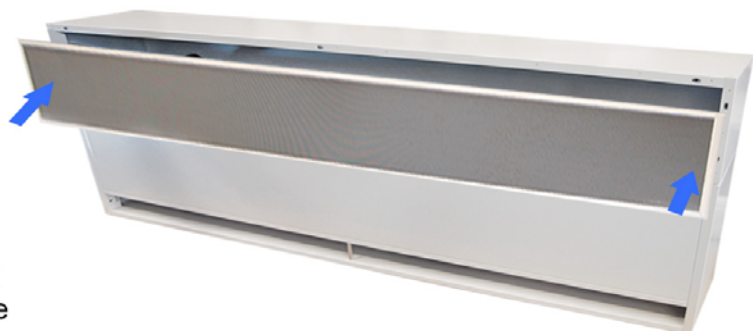

In case of the **Zen** air curtain model, the filter is accessible from the top part of the curtain, through the suction area. To carry out the maintenance, it is not necessary to remove the screws that fix the guides that hold the filters. Follow the instructions below to disassemble the filters easily. It is advisable to carry out this maintenance periodically to achieve the best efficiency of the equipment.

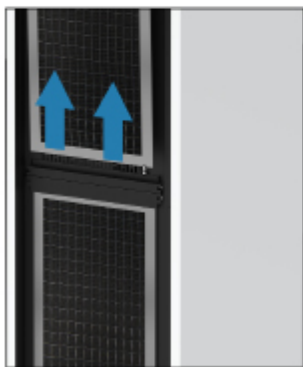
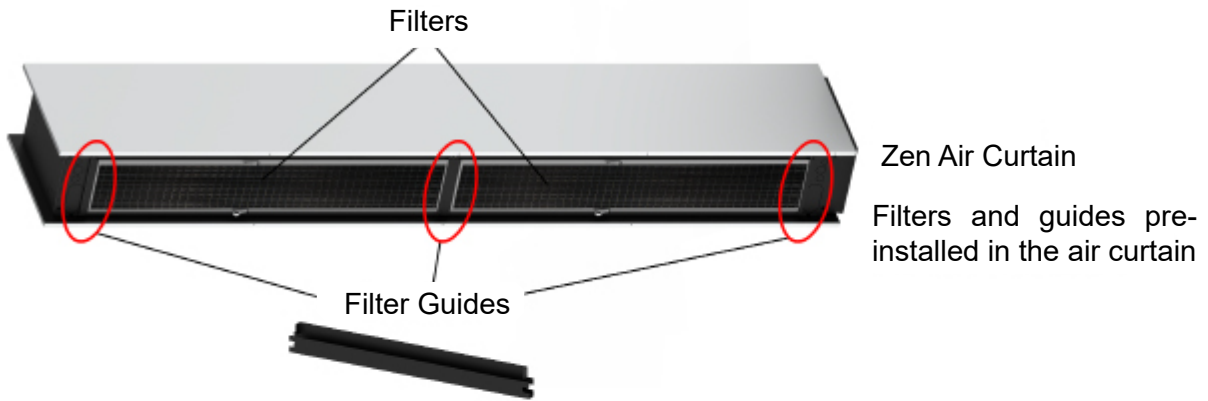

The filters can be removed without disassembling the guides. Simply push it to the side and lift it out of the guide.
Clean the filter gently with a Hoover.
Do the reverse process to put the filters back in place.

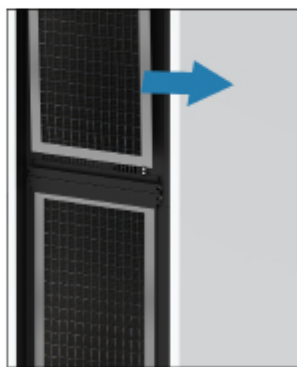

Suction grille cleaning

The suction grille prevents the entry of objects into the internal elements. It is highly recommended to check that the suction grille is free of any object that could prevent air from entering (plastic bags, paper, etc.). If the air curtain has a microperforated suction grille (it works as a prefilter and prevents dust from entering the internal elements), use a vacuum cleaner with a brush so as not to damage the microperforated grille. It is advisable to do it frequently (depending on the dirt generated) since performance is considerably reduced.

It is recommended to clean the suction grille monthly. In addition, it is important to make sure that the air curtain is off, otherwise the mixture between the dust and a damp cloth would form a paste of dirt that could damage the fan rotor when it sucks in the air or clog the water battery.

An annual cleaning of the discharge area must be carried out.



Exterior cleaning

Wipe the entire outer surface of the air curtain (except the suction grille) with a damp cloth to trap dust particles. In addition to the damp cloth, neutral soaps that do not contain acids or are caustic can be used.

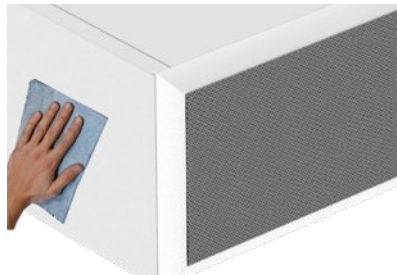

Interior cleaning

It is recommended to clean the inside of the unit with a vacuum cleaner at least once every 2 years. (*) It is recommended to clean the inside of the equipment frequently with the help of a vacuum cleaner, especially before the arrival of winter. (*)

(*) These periods are indicative depending on the conditions of each installation. In places with a high number of suspended particles, it is desirable to increase the frequency of interior cleaning.



Internal components visual inspection

Check that the regulation board has not suffered any damage and it is securely fastened to the equipment frame. Make sure that the board and internal wiring connectors are still well connected. Check that the motors do not move from their mountings and check that the turbines have no impediments to rotate freely (turn it by hand, first turn off the device).





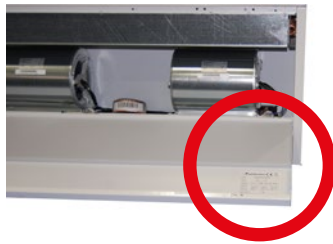

Consumption and auditory control checking

Write down the consumption value of the fans that appears on the product label (located on the inside of the service door). Close the door, give power supply to the air curtain and with the help of an ammeter, check that the electrical consumption of the air curtain at maximum speed is between 110% and 85% of the value indicated on the label. Check that all fans blow air. Keep the air curtain at full speed for a few minutes and listen for abnormal noises from the air curtain.



REPAIRS AND REPLACEMENTS

Assembly and electrical connection must be carried out exclusively by specialized professionals and in compliance with these instructions.
Before carrying out any repair, it is necessary to:

	<ul style="list-style-type: none"> • Notify staff and indicate that work is being done. • Disconnect the current and protect the circuit breaker.
	<ul style="list-style-type: none"> • Be sure there is no voltage in the unit.
	<ul style="list-style-type: none"> • Be sure the fans have stopped. • Use only original spare parts.
	<p>For manipulation safety, being it assembling, transport or maintenance duties it's a must to wear the correct individual protection equipment recommended. Those being gloves, insulating shoes, goggles and helmet.</p>



CODE	COMPONENT	COMPONENT REFERENCE	AIR CURTAIN MODEL
AIRCON12681	EC Windbox 5 speed heat pump PCB	PCB-5SE-HP-RJ11	ECM - ECG : Heat pump
AIRSEC99210	EC centrifugal fan	GDSG9 146X188R N46-A0 EC	ECM - ECG : All models
ELACCO33005	ADVANCED PRO Control RJ11	CON-LCD-RJ11	All models

Service door opening

Windbox: To open the service door, follow these steps:



1.- Insert a flat screwdriver between the casing and the grille and push the grill out. The grille is closed by pressure through pivots. It has a safety cable to avoid accidental falls.



2.- **OPTIONAL:** Remove the security screw of the service door.

3.- Insert a screwdriver and press close to the pivots to open the service door.

In case of an air curtain with **plenum or inlet/outlet kits**, the lever must be done from the side of the door where there is an oblong hole, to make it easier the entrance of a flat screwdriver.

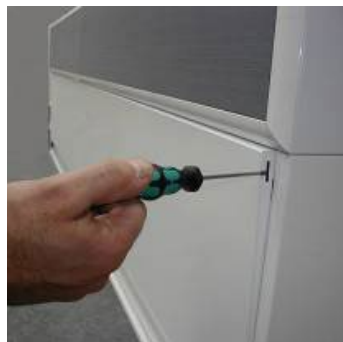

Dam: Follow the same instructions as for the Windbox air curtain with plenum or inlet/outlet kits.

Recessed Windbox: To open the service door in Recessed Windbox models follow the next steps:

1.- With a screwdriver remove the security screws from the service door.

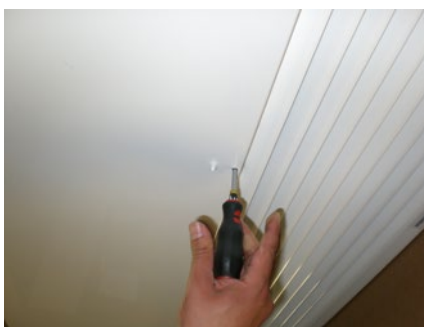

2.- Open the service door with both hands as indicated. The grille is closed by pressure clamps. The door is also closed by pressure through bollard. Both are pivoting. It's possible to open the big door first or open it with the help of the door with grille.

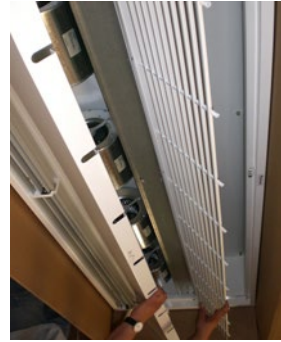

Recessed Dam: Remove the two security screws on both sides of the air curtain and open the suction grille with both hands.

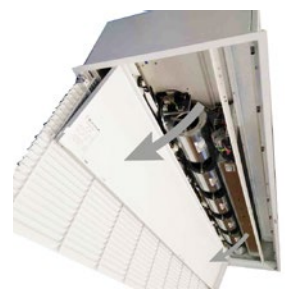

Invisair / Rotowind: To open the service panel and access the insides of the air curtain, remove the screws from the service door and pull to the outside to disengage it from the security screw and finally be able to open the service door with both hands.



Smart: Remove the screws from the service door and open the panel with both hands.



Zen: Remove the security screws from the top part of the air curtain. Open the service door with both hands. If it's necessary, remove the security cables and extract the panel sliding it to the side of the air curtain.

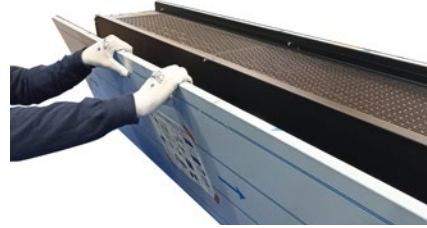

Rund: Remove the screws from the suction grille and open it using both hands.



Remove the screws that attach the battery casing. Remove the screws securing the service panel to the curtain cabinet.



Open the service panel with both hands to have access to the insides of the air curtain.



Fan replacement

Before replacing the fan, inform people that there is work in progress. Stop the air curtain through the controller and disconnect the main power supply. Check the unit has no tension and the fans have stopped. Identify and unplug the cables from the fan. Remove the screws that attach the fan to the structure and assemble the new one following the process in reverse order.

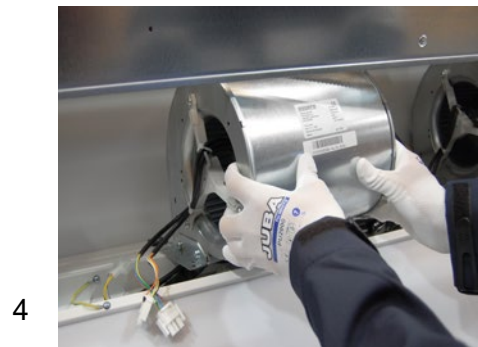
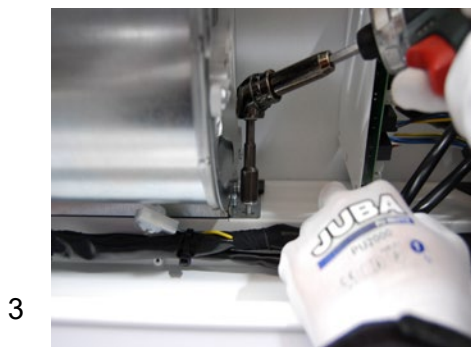
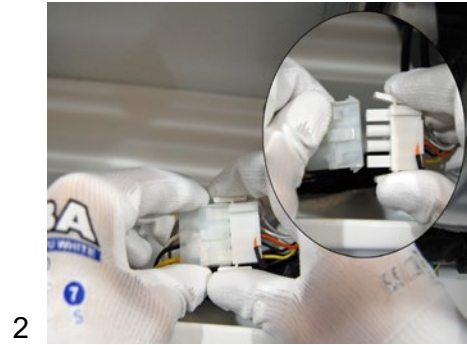

PCB and fuse replacement

Before changing the PCB or the fuse, inform people that there is work in progress. Stop the air curtain through the controller and disconnect the main power supply. Check the unit has no tension and the fans have stopped.

Change the PCB: open the service door and unscrew the PCB from inside the air curtain in order to do the necessary repairs to it.

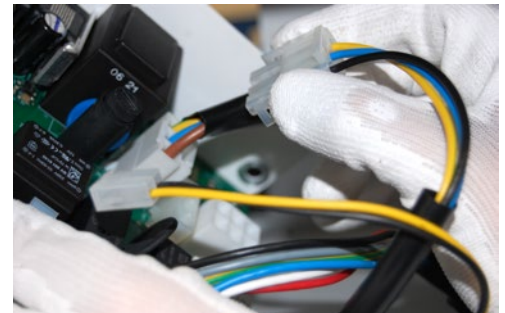
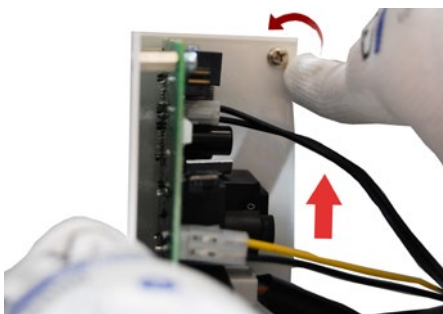

Change the fuse: open the service door and extract the fuse from the PCB by hand or with the help of a screwdriver pressing on the fuse cap and turning it counterclockwise. In some cases, it's recommended to unscrew the PCB to work better.

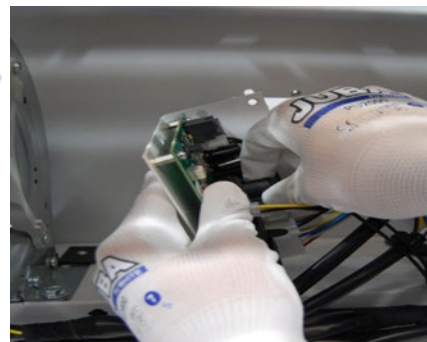

Recommendation: installation with silentblocks

To reduce the sound level and the vibrations of the air curtain, it is recommended to carry out an installation with silentblocks:

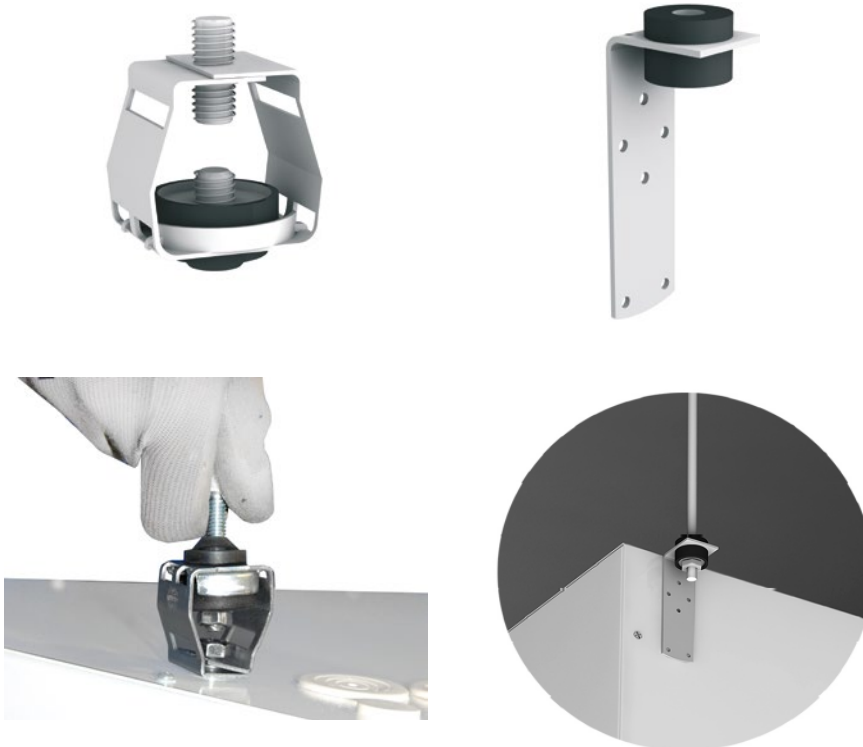



TROUBLESHOOTING

More than 95% of the claims occur **during the start-up** of the equipment and **are due to installation errors**. Reviewing the following points solves more than 90% of the incidents:

A) RJ11 cable manipulated: the cable connecting the control to the air curtain is an 4-way RJ11 cable. If it is manipulated (cut or remove the connector) and spliced backwards, the shade will not work properly and may also damage the electronics. Only re-splicing the connector correctly solves the problem (connection diagram).

B) Incorrect power supply. The supply of the air curtain depends on the type of current available and the type of heating of the equipment. Check bounding jumper if required, according to the wiring diagram.

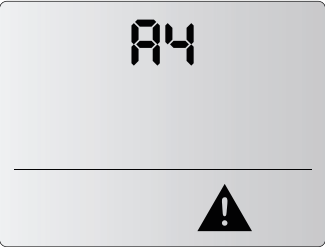
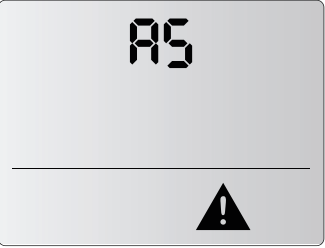
Most commons problems and solutions		
Symptom	Problem	Solution
No light on LCD control	Is the RJ11 cable the original without splices or shortening?	Change the cable or reconnect it correctly.
	Does the current reach the connection box?	Correctly connect the terminals of the connection box: Between L and N there must be 230V. If the curtain has a three-phase electric battery, there must be 400V between terminals L1, L2 and L3.
	Is the fuse on the board in good condition?	Check the fuse and change it if necessary (type T, slow action).

Alarms Lists		
Comment	Problem and Alert	Solution
Alarms will remain fixed on the display because it affects to the device functioning. Some lights on the remote control flash and an alert sign will appear in the display. Alarms will be shown as an "A" followed by a number to indicate the code of the alarm.	Communications error (A4) <div style="text-align: center; border: 1px solid gray; padding: 10px; width: fit-content; margin: 0 auto;">  </div>	No unit found. When this error appears, the user can do a scan to find the PCBs pressing the ON/OFF button during 10 seconds.
	Inappropriate device (A5) <div style="text-align: center; border: 1px solid gray; padding: 10px; width: fit-content; margin: 0 auto;">  </div>	Wrong combination of 2 different heatings (electric with water or heat pump) It is only possible to mix unheated units with one type of heating units.
	Fire Alarm (A6) <div style="text-align: center; border: 1px solid gray; padding: 10px; width: fit-content; margin: 0 auto;">  </div>	Stops and locks the unit. To unlock it, the power supply must be switched off. It is activated with DIN3 digital IN on the control unit.

Error Lists

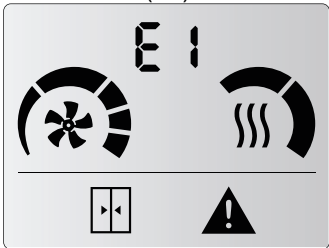
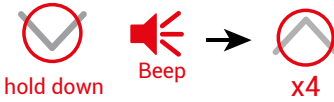
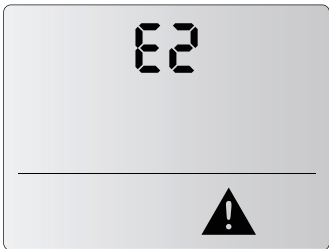
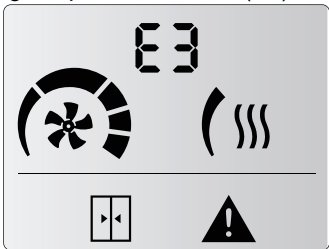
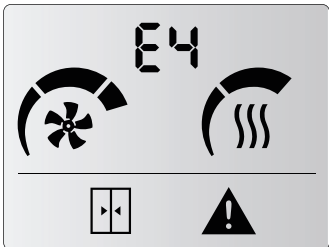
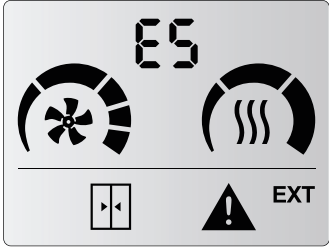
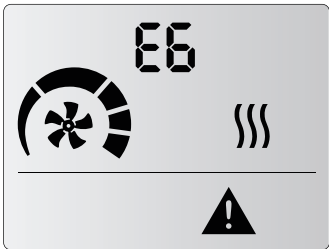
Comment	Problem	Solution
<p>Errors will not remain on the display, they will alternate with the ambient temperature. Unit operation remains working normal or adapted. Some lights on the remote control flash and an alert sign will appear in the display. Errors will be shown as an "E" followed by a number to indicate the code of the error.</p>	<p>Filter/maintenance (E1)</p> 	<p>Indicates filter change or cleaning / maintenance. This alarm is activated by time counter. It does not affect operation. To reset the counter:</p>  <p style="text-align: center;">hold down Beep x4</p>
	<p>Missing device (E2)</p> 	<p>One of the working units is not found. Please consult service to check the unit. To reset, turn OFF the power or scan the other PCBs by pressing the ON/OFF button during 10 seconds. Other devices remain working normally. Check the connections between units to see that none is wrongly connected.</p>
	<p>Missing temperature sensor (E3)</p> 	<p>Missing temperature sensor or temperature out of range. Unit operation adapts and remains working according to inbuilt room temperature sensor.</p>
	<p>Fan Error (E4)</p> 	<p>Some fan has stopped. Check the unit. Unit operation remains normal. Not available in 2-speed range.</p>
	<p>External Alarm (E5)</p> 	<p>Indicates an external alarm. Unit operation remains normal. Only programmable with CLEVER PRO control (consult CLEVER PRO Manual).</p>
	<p>E6 - Additional PCB Error</p> 	<p>Additional PCB inside the same air curtain has an error or is disconnected. In case of electrical heater, heating stops.</p>

DECLARATION OF CONFORMITY



Declaration  of conformity / Declaración  de conformidad

Manufacturer **Motors i Ventiladors S.L. (AIRTECNICS)**
Fabricante **Conca de Barberà 6, Pol. Ind. Pla de la Bruguera**
08211 Castellar del Vallès (Barcelona) Spain

We declare, under our sole responsibility, that the product(s)
Declaramos, bajo nuestra única responsabilidad, que el/los producto(s)

Air Curtains / Cortinas de aire

with models
con los modelos

Air curtains DX / Cortinas de aire DX

is/are developed, designed and manufactured in accordance with the following directive(s)
ha(n) sido desarrollado(s), diseñado(s) y fabricado(s) de acuerdo con la(s) siguiente(s) directiva(s)

Low Voltage Directive 2014/35/UE
Directiva Baja Tensión 2014/35/UE

Electromagnetic Compatibility Directive 2014/30/UE
Directiva Compatibilidad Electromagnética 2014/30/UE

Restriction Certain Hazardous Substances Directive 2011/65/EU (RoHS)
Directiva Restricción Substancias Peligrosas 2011/65/EU

Eco-design Energy-related Products Directive 2009/125/EC
Directiva Diseño Ecológico Productos Con Energía 2009/125/CE

Remark: *The installer is responsible for making the whole heating system comply with the PED directive.*

Mención: *El instalador es el responsable de hacer que todo el sistema de calefacción cumpla con la directiva PED.*

applying the following harmonized standards in particular
aplicando las siguientes normas armonizadas en particular

LVD: EN 60335-1:2012 + AC:2014 + A11:2014 + A13:2017 + A1:2019 + A14:2019 + A2:2019
EN 60335-2-30:2009 + A11:2012 + A1:2020 + A12:2020

EMC: EN 61000-3-11:2020
EN 61000-3-12:2011
EN 55014-1:2017 + A11:2020
EN 55014-2:2015
EN 62233:2008 + AC:2008

RoHS: EN 50581:2012

Date / Fecha
Name / Nombre
Position / Cargo

04/03/2024
Jordi Hierro
Technical Manager

AIRTECNICS EXPORT, S.L.
C/Conca de Barberà, 5 - Pla Bruguera
08211 CASTELLAR DEL VALLÈS
Tel. +34 93 714 36 36
CIF: ESB66276171

Conca de Barberà, 6 - Pol. Ind. Pla de la Bruguera
E-08211 Castellar del Vallès (Barcelona) Spain
☎ + 34 93 715 99 88
airtecnicos@airtecnicos.com

www.airtecnicos.com

