

Air curtains: Recessed windbox (M-ECM-G-ECG, SB-BB), Recessed DAM and Recessed Compact (M-ECM-G-ECG)



INSTALLATION, OPERATION AND MAINTENANCE MANUAL



*Please, read these instructions carefully before attempting installation
Deliver this manual to the final user.*

SECURITY ADVISE SYMBOLS



Attention, Danger, Safety Advice!



Danger from electric current or high voltage!



Injuries risk!



Danger! Do not stay underneath: Heavy load.



Important information.

INDEX

CAUTIONS	4
INSTALLATION	5
TRANSPORTATION AND STORAGE	13
OPERATING INSTRUCTIONS.....	13
WIRING DIAGRAMS	24
DATASHEET.....	32
MAINTENANCE INSTRUCTIONS	43
REPAIRS AND REPLACEMENTS	47
TROUBLESHOOTING	53
DECLARATION OF CONFORMITY	56
IDENTIFICATOR	57
GUARANTEE	57

CAUTIONS

IMPORTANT INSTRUCTIONS

Please before installing or using the air curtain, read carefully all instructions and considerations to reduce the risk of fire, electric shock, injury to people or damage to the air curtain itself. For that is recommended to follow the next basic precautions:

1. Use the air curtain only in the manner intended by the manufacturer and described in this manual. Any other use not recommended may increase the risks mentioned before.
2. Installation work and electrical wiring must be done by a qualified technician. Be also careful to not damage electrical wiring or hidden utilities when cutting or drilling into a wall or ceiling.
3. The air curtain is a heavy appliance and for that matter it must be elevated with proper lifting tools to prevent injuries to the people who install it.
4. Before servicing or cleaning the unit, switch power off at service pannel and lock the service disconnecting the means to prevent being switched on accidentally. When the service protection elements cannot be locked, securely fasten a prominent warning device, such as a tag, to the service panel.
5. It's HIGHLY recommended to do a periodical maintenance as stated in this manual section following the instructions given to clean the inlet grille, visual inspect each part and prevent any possible malfunction or issue of the air curtain before it happens.
6. Do not operate any air curtain after it malfunctions. Disconnect power at service panel and have air curtain inspected by a qualified technician before reusing.
7. To disconnect the air curtain, turn the control "OFF", wait 10 minutes for the device to stop completely and then turn off power supply to the air curtain.
8. The air curtains with heating are hot when in use. To avoid burns, do not let bare skin touch hot surfaces. Keep combustible materials, such as furniture, pillows, bedding, papers, clothes, etc at least 3cm (1 inch) from the top, back, front, sides and at least 180cm (6 feet) from the discharge of the air curtain.
9. To prevent a fire, do not block the air intake or discharge of the air curtain in any manner. Also prevent any foreign objects to enter any ventilation or exhaust opening as it may cause an electric shock, fire or damage the air curtain.
10. The air curtain has hot and may have arcing or sparking parts inside. Do not use it in areas where gasoline, paint or flammable vapors or liquids are used or stored.
11. Extreme caution is necessary when any air curtain is used by or near children, elderly or invalids, and whenever the air curtain is left operating unattended.
12. Some air curtain may include a visual alarm to warn that parts of the air curtain are getting excessively hot. If the overheating alarm is active because inside the temperature is rising too much, then the air curtain protects itself changing the functioning by increasing ventilation speeds and/or reducing heating stages. Check Troubleshooting part in this manual for more info about how to proceed.
13. Air curtains must not be installed outdoors unless is intended for outdoor use. If so, the air curtain should be always protected against rain and it's recommended a special protection to prevent corrosion and other issues caused by the environment (optional).
14. In case of vertical air curtains, these MUST be installed in a leveled floor for optimal performance and prevention of accidents.
15. The optimal working temperature of the fans is between 5°C and 40°C (41°F to 104°F) to protect the electrical components and at most should not exceed 50°C (122°F).

KEEP THESE INSTRUCTIONS

INSTALLATION

Tips and recommendations for a good installation

LENGTH

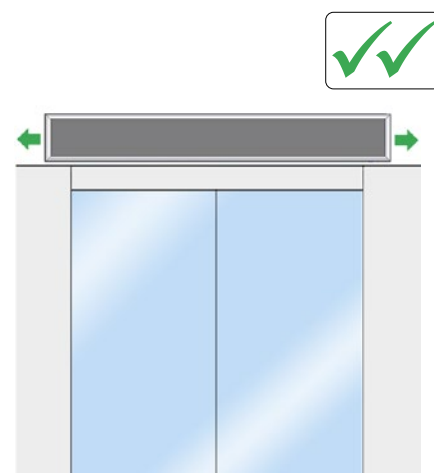
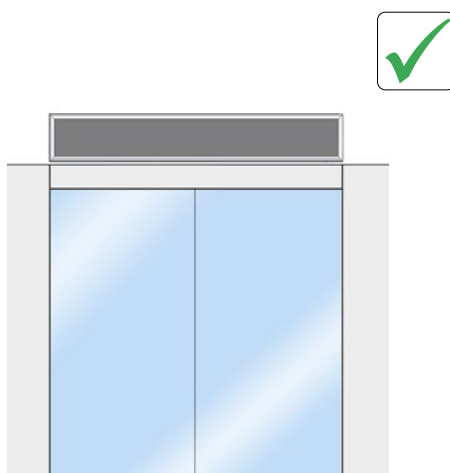
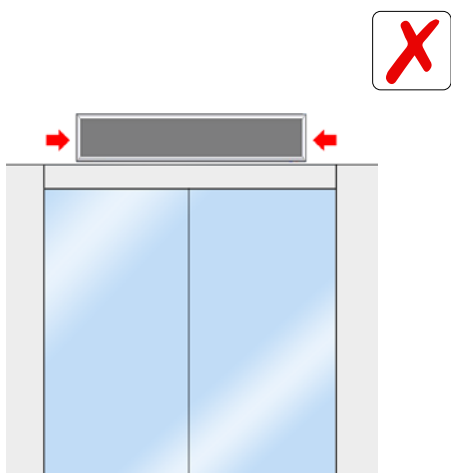

CENTERED / HEIGHT

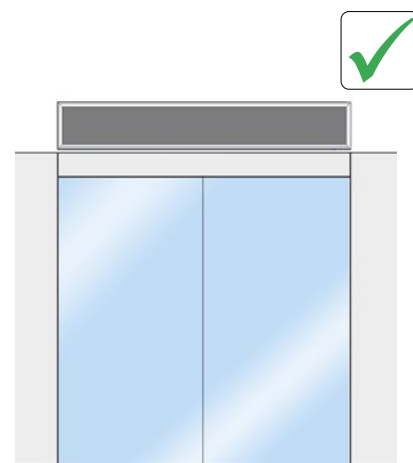
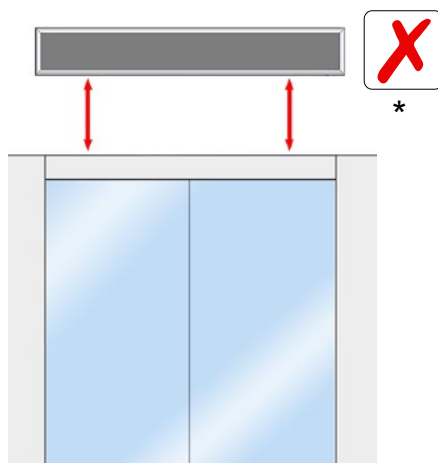
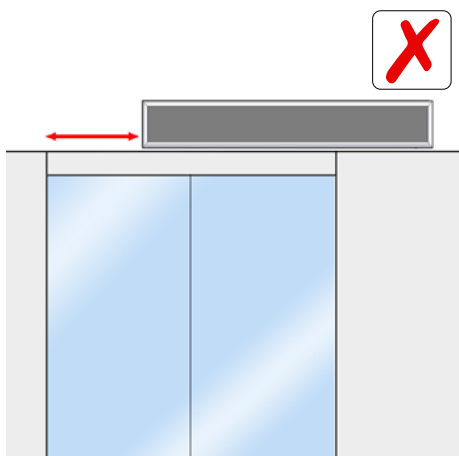

(*) Unless it has been designed to be installed at that height.

DOOR DISTANCE

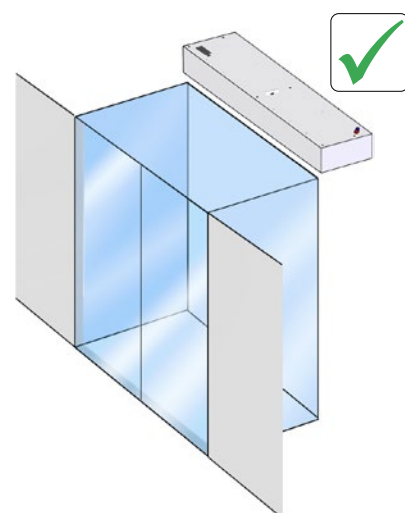
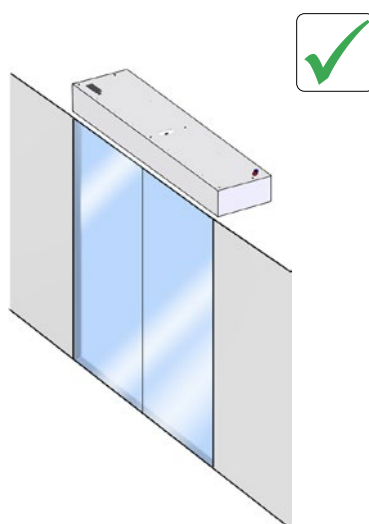
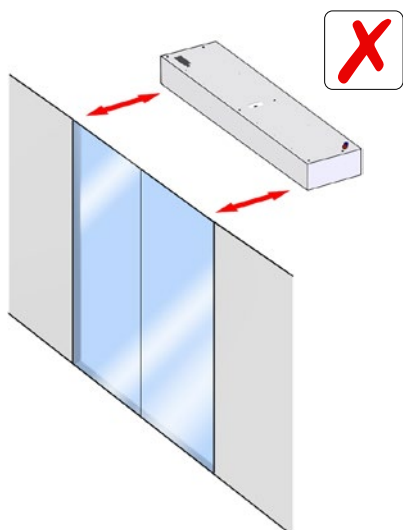

AIR DISCHARGE

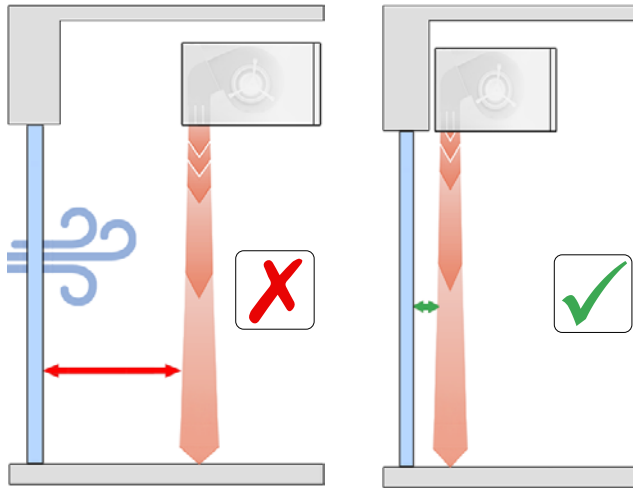

AIR ASPIRATION

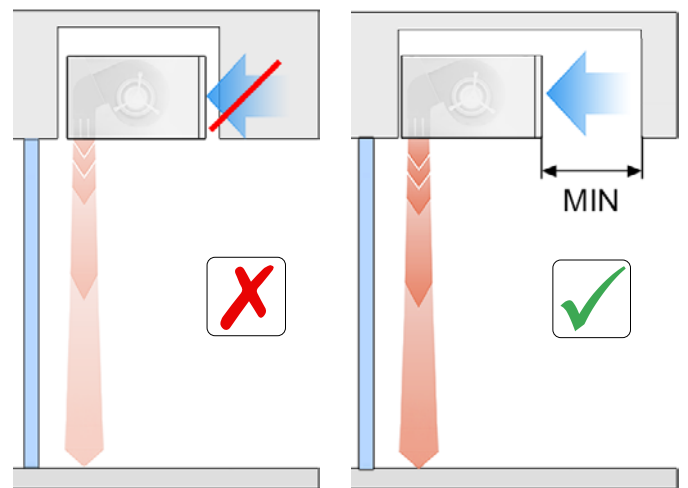

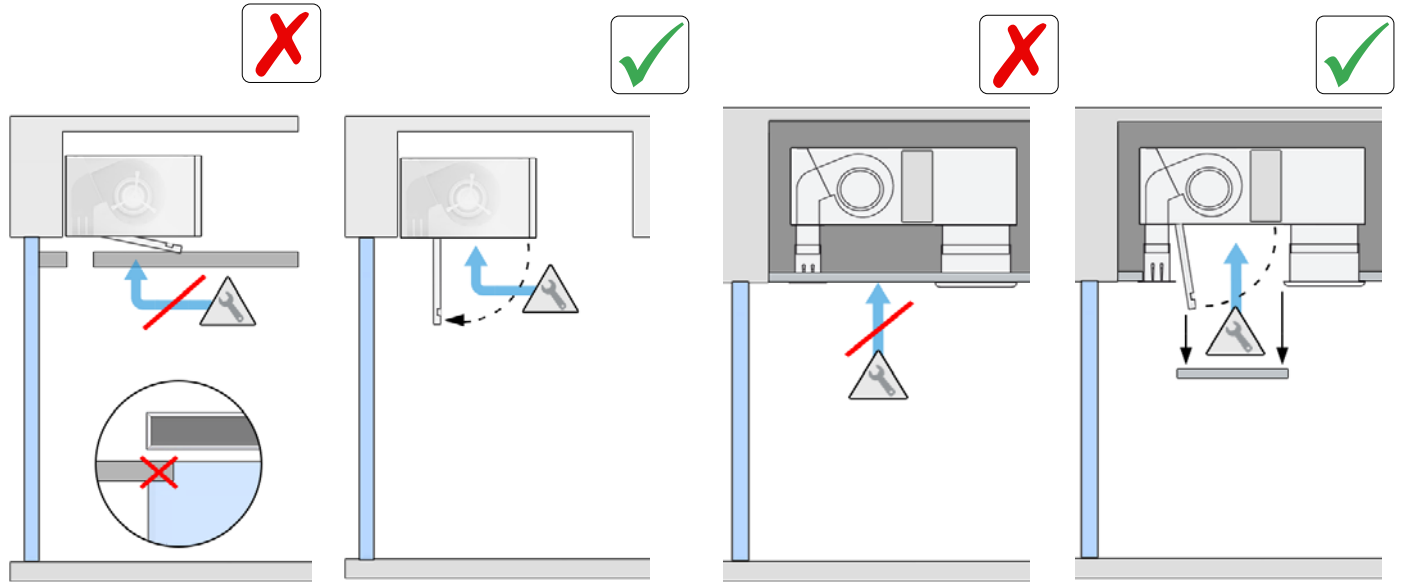

MAINTENANCE ACCESSIBILITY

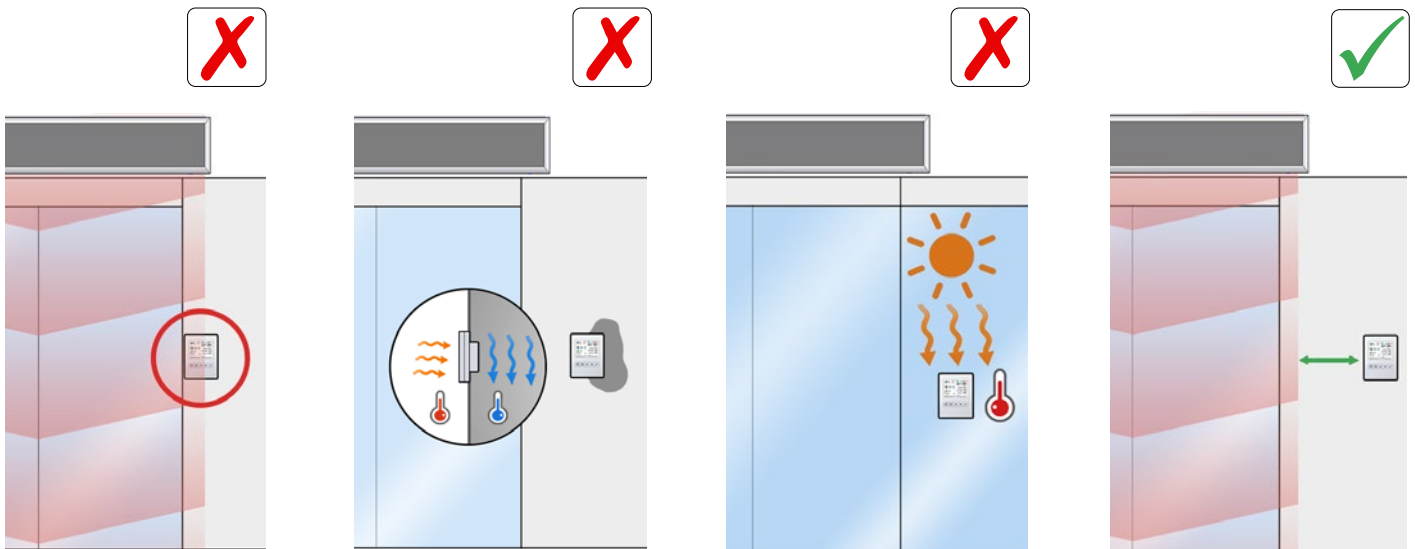

CONTROL



Recessed Windbox model

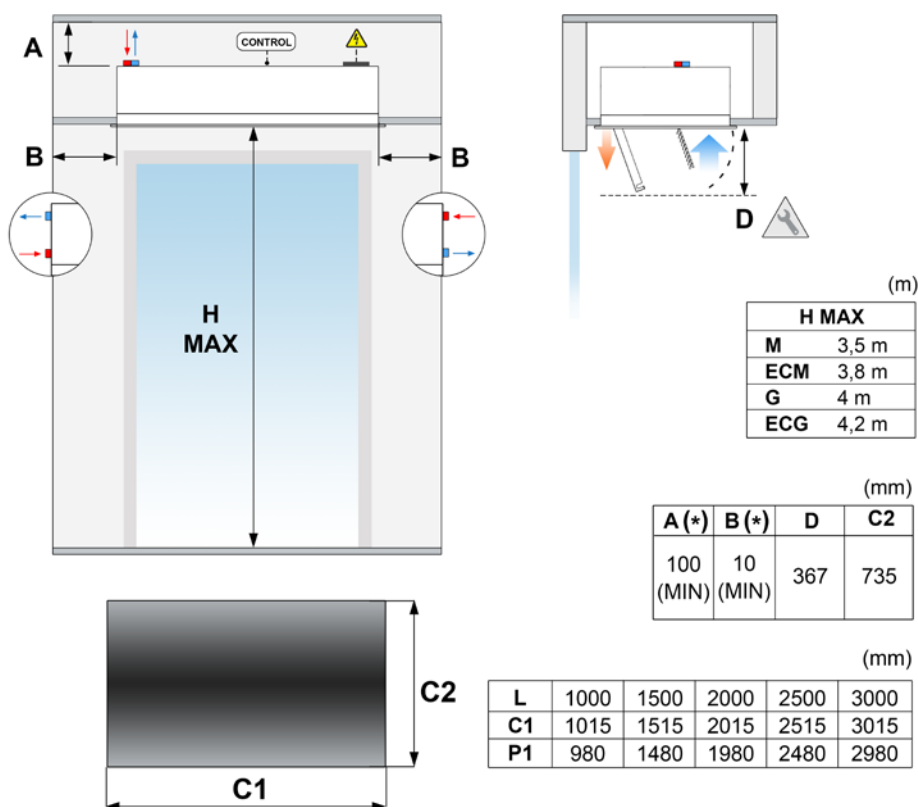

	<p>Installation work, connection, disconnection, electrical wiring, mechanical maintenance and service must be done by qualified people observing these instructions and in accordance with all applicable norms and standards.</p> <p>If the unit is operated with additional controller, please consider its specific instructions.</p>
	<p>There is no need to open the service door to connect the air curtain. All connections (power supply, control, water pipes when existing) and fixations are external. They are placed on top or lateral of the units. See how to open service door at repairs section.</p>
	<p>For safety, the air curtains never have to be stopped by disconnecting them from the main supply, always through the controller and waiting 10 minutes at least to disconnect the main supply. In case to not follow these instructions, the internal parts of the air curtain can be damaged.</p>



H MAX. Maximum recommended range, MIN. Recommended minimum distance

(*) Standard equipment. Upon request, the A distance can be reduced to 10 mm when the connections are located inside the equipment and the tube outlet is lateral. In this case, dimension B will be 100 mm. The minimum recommended distance between the suction grille and any obstacle is 200 mm (Dimension C) Dimension D: service opening distance.

Recessed DAM model

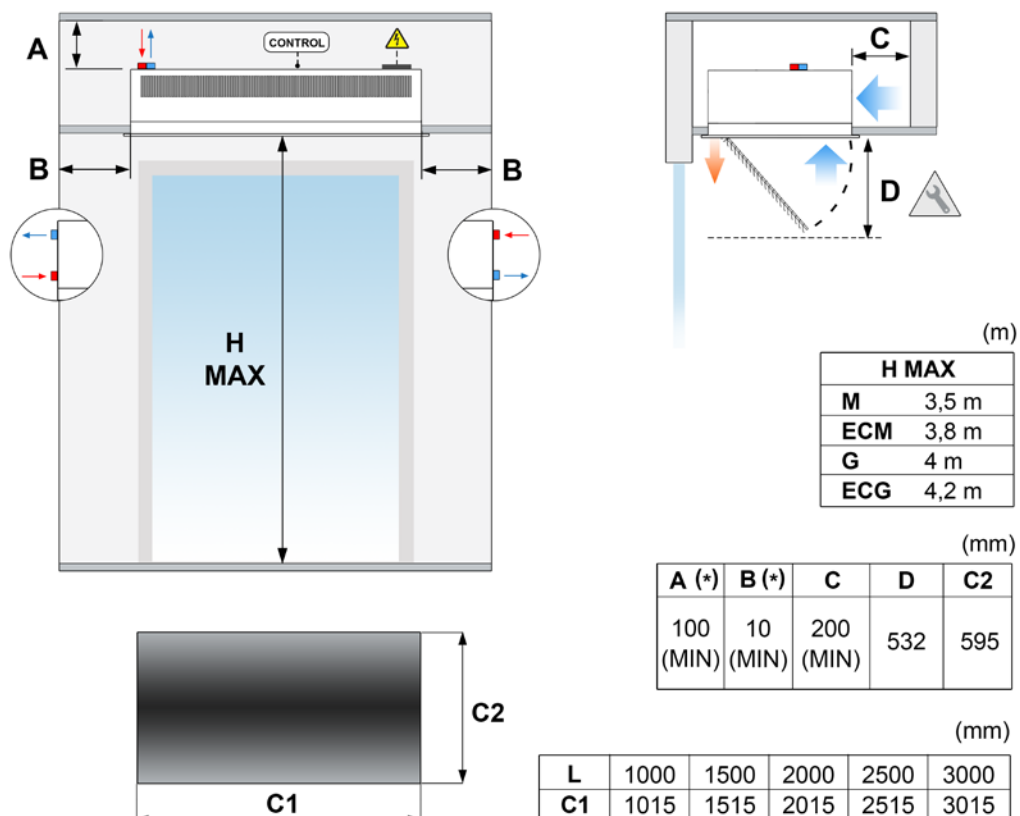

	<p>Installation work, connection, disconnection, electrical wiring, mechanical maintenance and service must be done by qualified people observing these instructions and in accordance with all applicable norms and standards.</p> <p>If the unit is operated with additional controller, please consider its specific instructions.</p>
	<p>There is no need to open the service door to connect the air curtain. All connections (power supply, control, water pipes when existing) and fixations are external. They are placed on top or lateral of the units. See how to open service door at repairs section.</p>
	<p>For safety, the air curtains never have to be stopped by disconnecting them from the main supply, always through the controller and waiting 10 minutes at least to disconnect the main supply. In case to not follow these instructions, the internal parts of the air curtain can be damaged.</p>



H MAX. Maximum recommended range, MIN. Recommended minimum distance

(*) Standard equipment. Upon request, the A distance can be reduced to 10 mm when the connections are located inside the equipment and the tube outlet is lateral. In this case, dimension B will be 100 mm. The minimum recommended distance between the suction grille and any obstacle is 200 mm (Dimension C) Dimension D: service opening distance.

Recessed Compact model

	<p>Installation work, connection, disconnection, electrical wiring, mechanical maintenance and service must be done by qualified people observing these instructions and in accordance with all applicable norms and standards.</p> <p>If the unit is operated with additional controller, please consider its specific instructions.</p>
	<p>There is no need to open the service door to connect the air curtain. All connections (power supply, control, water pipes when existing) and fixations are external. They are placed on top or lateral of the units. See how to open service door at repairs section.</p>
	<p>For safety, the air curtains never have to be stopped by disconnecting them from the main supply, always through the controller and waiting 10 minutes at least to disconnect the main supply. In case to not follow these instructions, the internal parts of the air curtain can be damaged.</p>

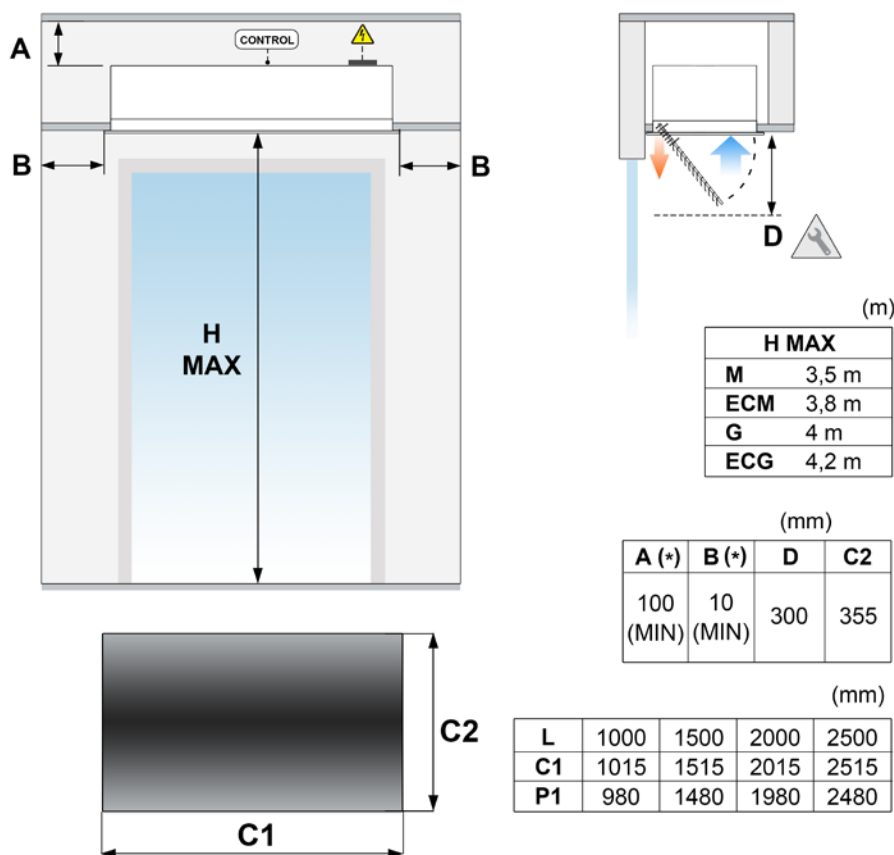

H MAX. Maximum recommended range, MIN. Recommended minimum distance

(*) Standard equipment. Upon request, the A distance can be reduced to 10 mm when the connections are located inside the equipment and the tube outlet is lateral. In this case, dimension B will be 100 mm. The minimum recommended distance between the suction grille and any obstacle is 200 mm (Dimension C) Dimension D: service opening distance.

Power supply

To connect the device to power, there is a black junction box at the top of the exterior of the air curtain.



For air curtains without heating or with water heating, the air curtain must only be connected to a 230V single-phase current for the operation of the fans.

In the case of an air curtain with an electric battery, connect the 400Vx3 three-phase power supply from the electric battery. Optionally, the battery power can be 230Vx3 three-phase or 230Vx1 single-phase (special diagram included).

The single-phase current is only connected to one phase of the three-phase lines, plus a connection to the neutral. Recommended maximum number of curtains connected to the same differential:

Modelo	Diferencial 30mA	Diferencial 300mA
M-G	20 uds.	20 uds.
ECM-ECG, SB-BB	2 uds.	20 uds.

Each installation must be reviewed by a specialist to ensure that there is no incompatibility with the selected differential and the connected curtains.

Control

To connect the control to the air curtain, there are terminals (COM1 or COM2) located on the outside top of the air curtain. It is not necessary to open the air curtain to connect it, except for internal connections. Use the 7 meter RJ11 cable supplied with the equipment and connect one side to the control and the other to COM1 or COM2 in the air curtain.



Fixings

The curtain has several external fastening points depending on the weight and length (see situation in the model characteristics section).

Generally, air curtains are installed horizontally. For vertical installation, use the feet kit (see accessories section). The anchor must be sized according to the weights of each curtain indicated on the technical data page. The installation can be done using threaded rods, tensioners or other supports (see available supports in the accessories section).

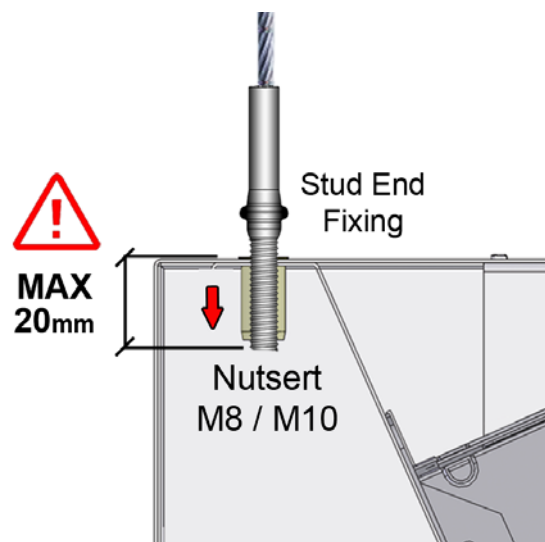

Air Curtain

Water heating

The air curtains with water heating have a 220-240Vx1 output to optionally connect an ON/OFF valve (it opens or closes the water inlet to the heat exchanger). It also includes either 24V or 0-10V output for proportional valve.

SOLENOID VALVE (*)

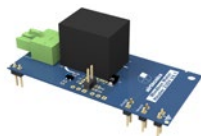

MODULATING VALVE (**)



This output can also be used for other low amperage electrical appliances (1,5A).

(*) By default (**) Under request, without price increase

Recommendations:

- Close the hot water flow (valve) to avoid overheating of the motors while the equipment is off. Optionally, Airtècnics offers solenoid and modulating valves.
- In the installation of the building, two shut-off valves (in and out) should be provided to be able to disassemble the equipment without problems.
- Mount a bleeding valve at the highest point of the heating section.

Antifreezing:

All the water heated air curtains include an antifreezing function. When room temperature is below 5°C and the valve is closed, the air curtain stops the ventilation and opens the valve to enable the water heating.

The water coils have a drain screw in the collector area to empty the water in case of maintenance (see repairs and replacements sections).

Electric heating

The electric battery has up to 15 resistances in the form of a bar that, combined with each other, provide 3 stages of heating. Control is carried out by three PRBEO or Contactors depending on the heating power and the fan range.

All the batteries are electrically and electronically protected against overheating (see section “Operating instructions”).

Electric controllers include an external thermostat to control heating based on temperature.

During the first uses, the electric battery can give off some odor that disappears in a few days.



According to battery power, the regulation is carried out by:

Range	Coil heating power (kW)	Regulation type
MG	9 / 12 / 15 / 18 / 22,5 / 24	PRBEO
SB	30 / 34 / 42	CONTACTORS
BB	21 / 27 / 42 / 46 / 50	CONTACTORS

TRANSPORTATION AND STORAGE



Warning! Heavy load.
Do not stand under the suspended load during transportation or assembly.

Store in a dry place protected from the environment. If the package is opened, cover the curtain to protect it from the dust. Do not step on or place heavy loads on it to avoid damage to the material. Storage temperature between -20 °C and +40 °C.

When transporting the material, you must ensure that it is not damaged by the forklift. (possible penetration of the fork in the packaging). Observe the instructions on the packaging for correct manipulation of the product.



OPERATING INSTRUCTIONS



For safety, the air curtains must never be stopped by disconnecting the current, always do it through the controller. If the power is turned off to turn off the shade, or within ten minutes of turning it off with the controller, internal components may be damaged.

LCD Control ADVANCED PRO

The **ADVANCED PRO** is a versatile Plug&Play air curtain control with communication via a standard 4-way RJ11 cable.

Compatible with all air curtain models:

- 2 and 5 ventilation speed
- Air only, heating with water coil, electric and heat pump.

Once connected, it will detect the model of the air curtain and configure itself automatically (number of speeds and type of heating).

The **ADVANCED PRO RJ11** control allows the selection of different speeds and heating stages for door open and door closed.

In addition, it limits the heating based on the set temperature according to the room temperature (optionally also with the outside temperature) and the door status.

A 'Boost' function is available when the door is open, which increases the heating to ensure comfort.

- Backlight LCD display indicates fan speed, heating stage, set, ambient and outdoor temperatures (if an additional sensor is installed outside the building), door status, alarms and errors, and external signals (EXT).
- Inbuild room thermostat to turn ON/OFF or modulate the heating according to set temperature.
- Ready for the installation of a potential-free door contact. This can be used to set one speed and heating stage for open door and another for closed door.
- It has 3 digital inputs with different functions depending on the air curtain model connected (OFF outside, OFF heating, fire alarm, etc.).
- Maximum speed and heating settings for open door and closed door, boost mode, memory, etc.

Screen and Button Layout:

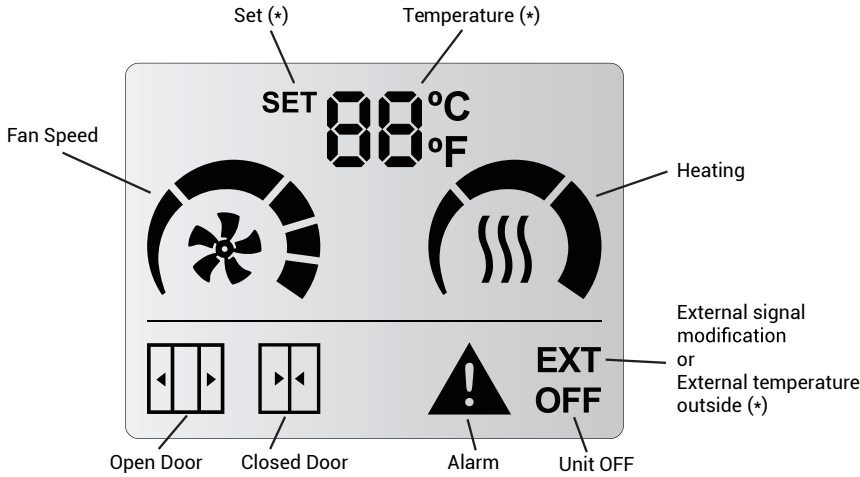

Room	
SET	
External (optional)	
Discharge	
Inlet (optional)	

Button Layout:



- ON/OFF (circle with line) allows to return to previous screen in Menus and starts/stops the air curtain.
- Use the arrows to set the temperature when electrical/water.
- User Menu to configure (3 lines):
 - Door open and door close ventilation speed.
 - Door open and door close heating stage.
 - Set temperature when electrical/water.

User Functioning:

The display will know what functional limits exists and will only show the parameters that the user can modify.

- **Temperature SET:** the desired temperature can be set between 10°C and 35°C. Below 10°C and above 35°C, the user can select “no” and the heating will not be limited by temperature (thermostat mode deactivated).
- **Fan Speed:** user can select one fan speed for open and another for closed door. If the speed is set to 0 then the unit will be off.
 - **Slave DX (P2):** Only one speed can be selected when the heat pump is running.
 - **Interface Slave (P0):** The speeds are selected via the control of the heat pump brand.
- **Heating:** it depends on the air curtain model:
 - **Only Air:** It has no heating.
 - **Electrical heated:** The user can select the heating stage based on the configured ventilation speed and the door’s status.
 - **Water heated (ON/OFF):** The user can select the valve’s on or off state (optional), depending on the configured ventilation speed and the door’s status.
 - **Modulating heating:** The user can select the heating stage based on the configured ventilation speed and the door’s status.

Device Initialization

When the control is powered, the display will show the firmware version and subversion, the input/output program it is working on and how many PCBs are connected to the control.

Example: Displays show with a V01.02 version, a P1 configuration of inputs/outputs and 2 PCBs connected.

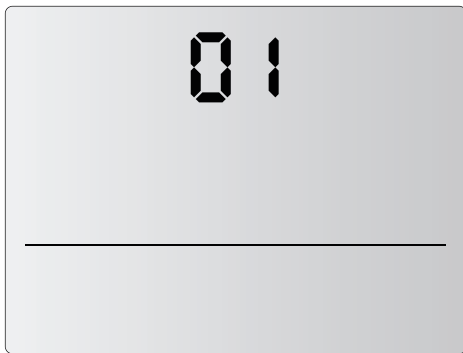

ADVANCED PRO version: 01

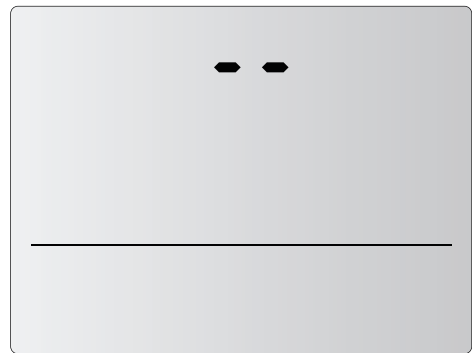

Space between version and sub-version.

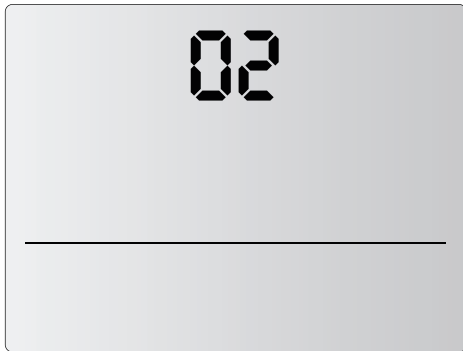

ADVANCED PRO subversion: 02

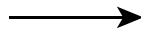

Scanning units.

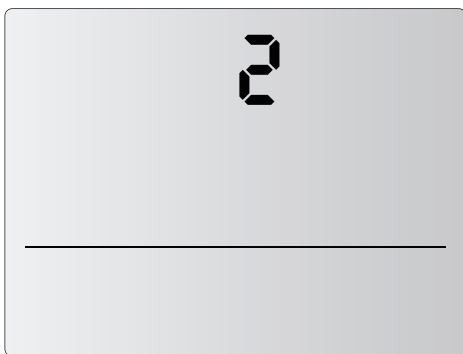

2 units connected to the control
(last number shown during initialization)

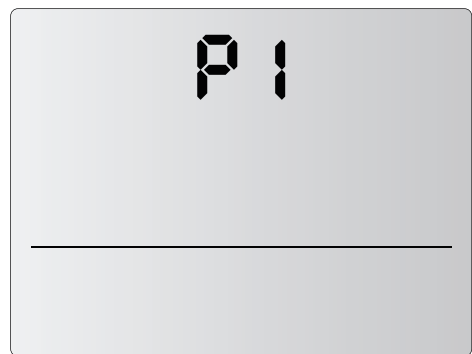
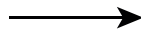

Unit Working in P1.

LCD User Menu Flow

Once the control has been initialised, the user can select the ventilation speeds and heating stages at which the air curtain is wanted to operate. To do this, the user may follow the diagram below:

Menu Flow for Only Air (Non-heated) models:

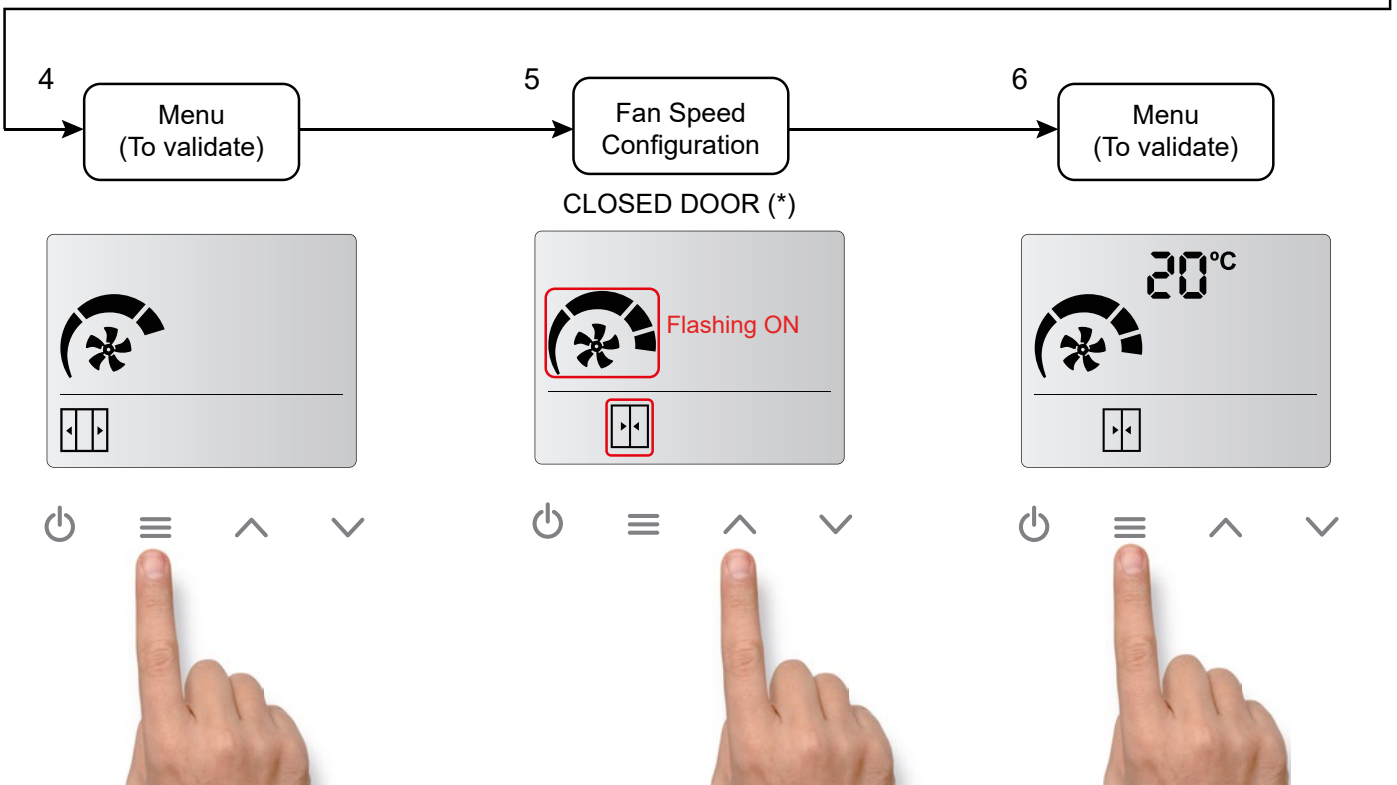
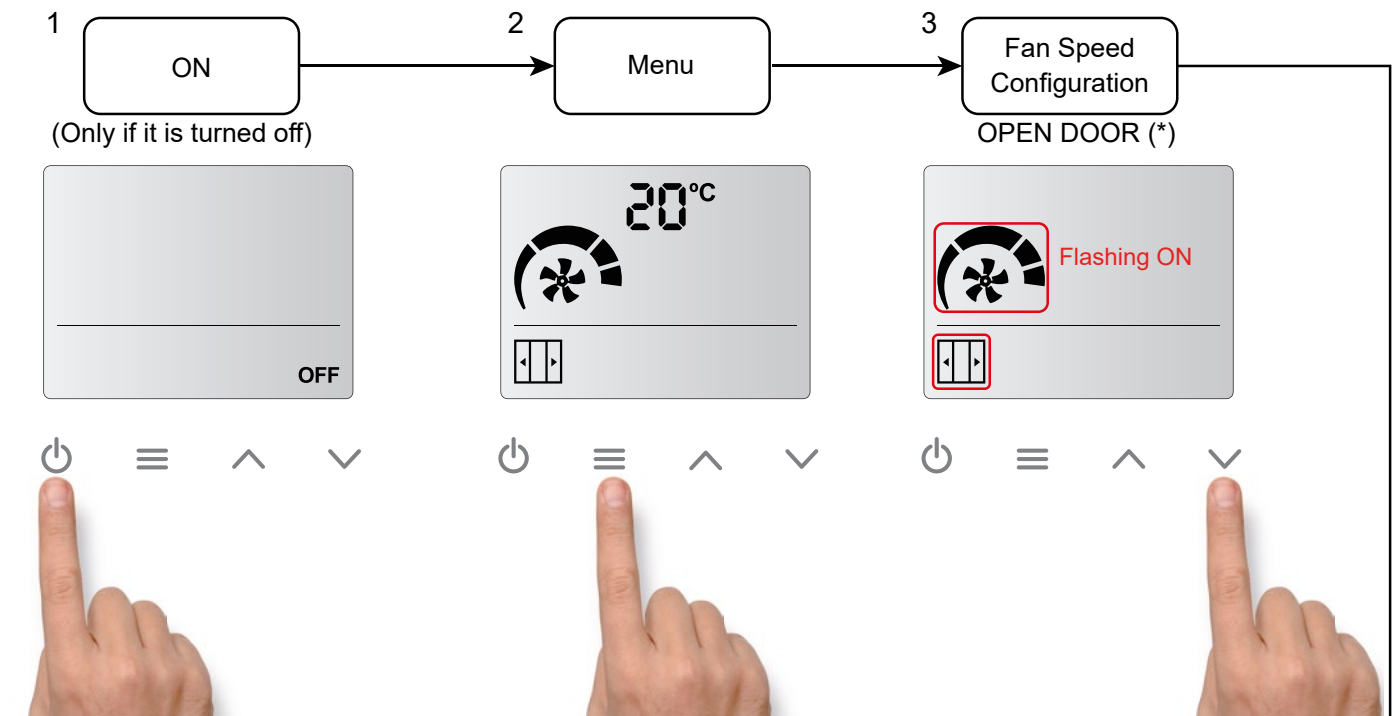

(*) If the door contact is not detected, the door open and door closed icons will not appear. Only one speed and one heating will be available.

For the door icons to appear, a door contact must be connected to the 'PCB DIN1' input and a door opening and closing cycle must be performed.

Menu Flow for heated air curtains models (it's the same process for electric heated, water heated or heat pump units) with CD control:

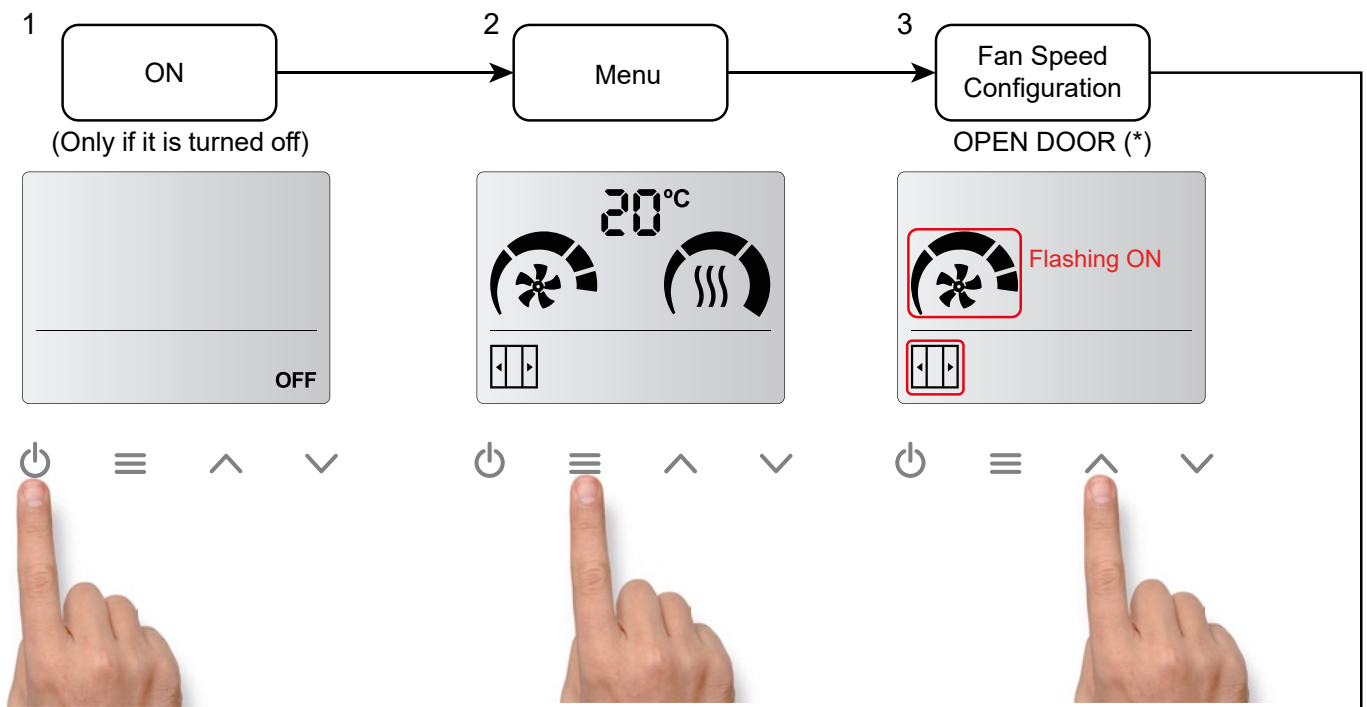

When turn on the unit or power supply is restored: if memory is ON, it will return to the configuration it had before turn off or external incident (power supply fail).

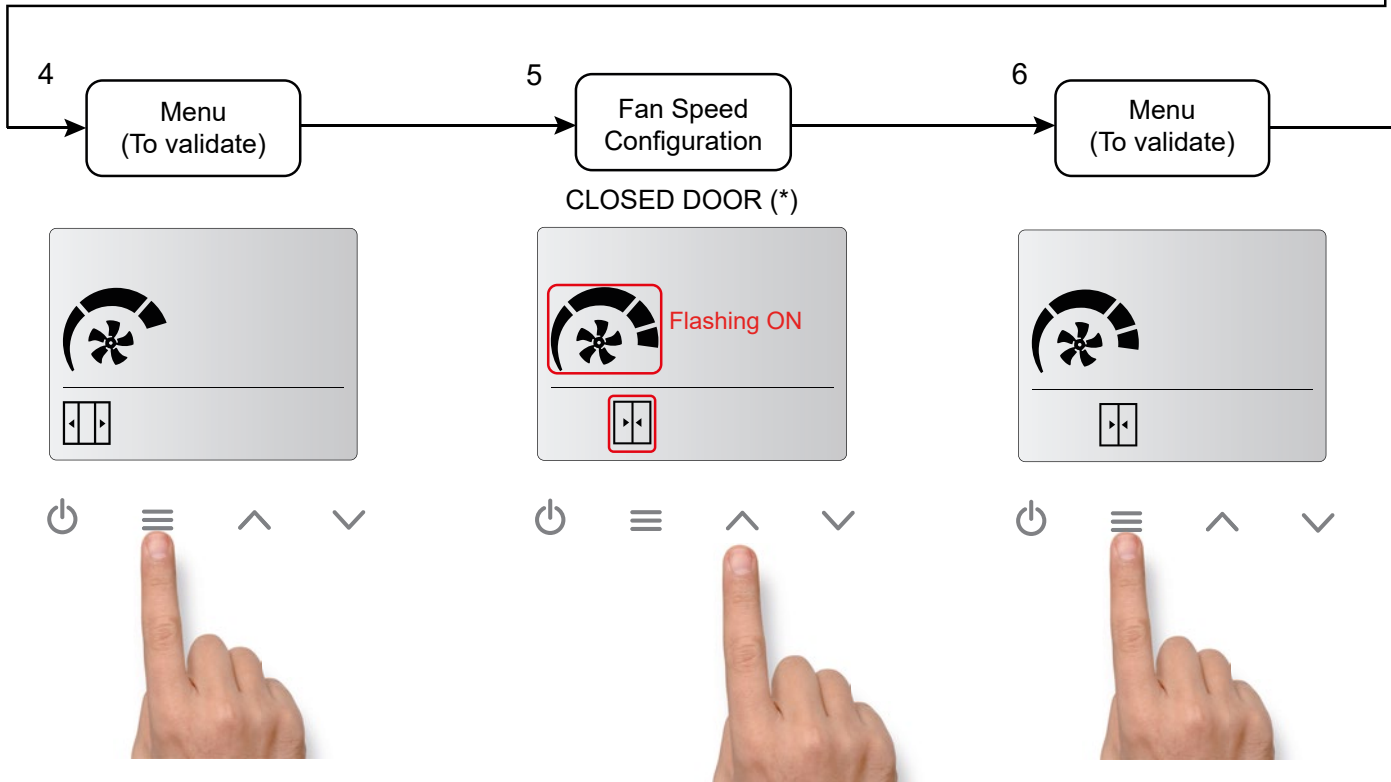

(*) If the door contact is not detected, the door open and door closed icons will not appear. Only one speed and one heating will be available. For the door icons to appear, a door contact must be connected to the 'PCB DIN1' input and a door opening and closing cycle must be performed.

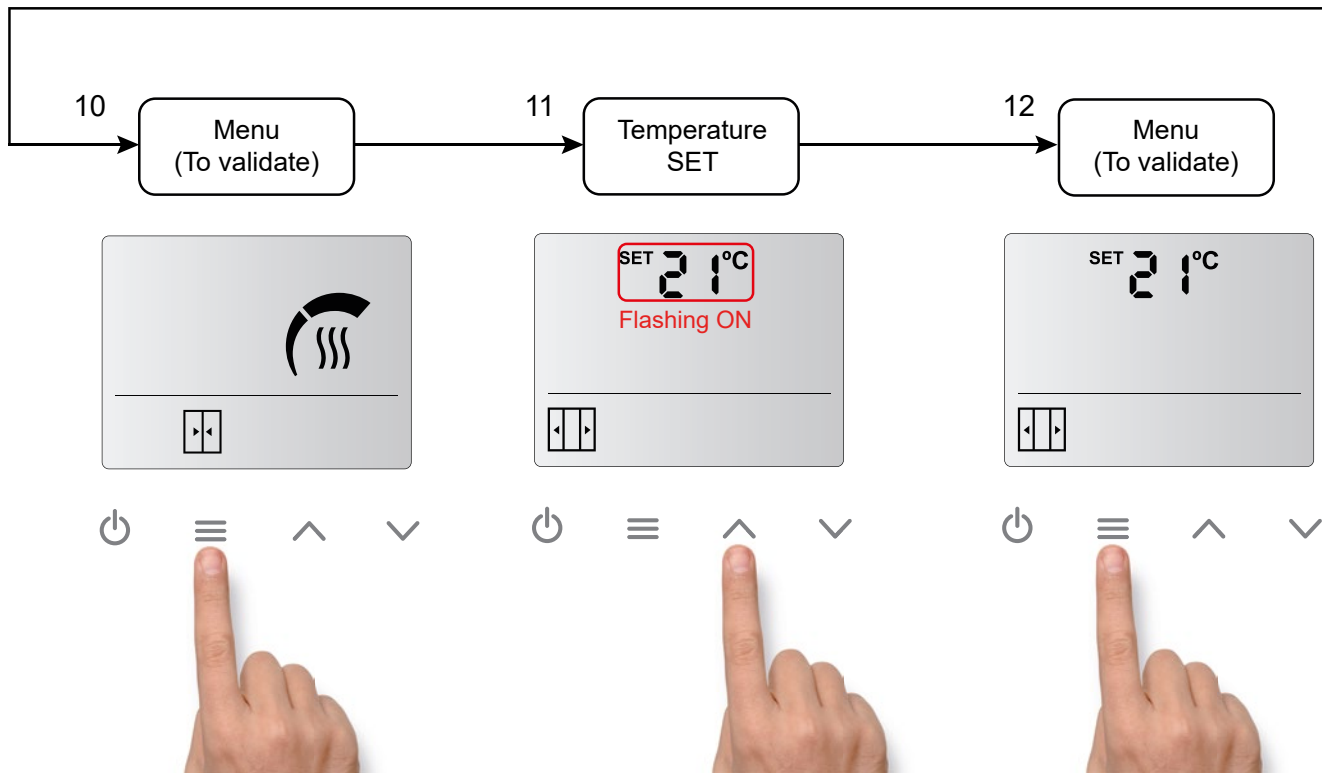
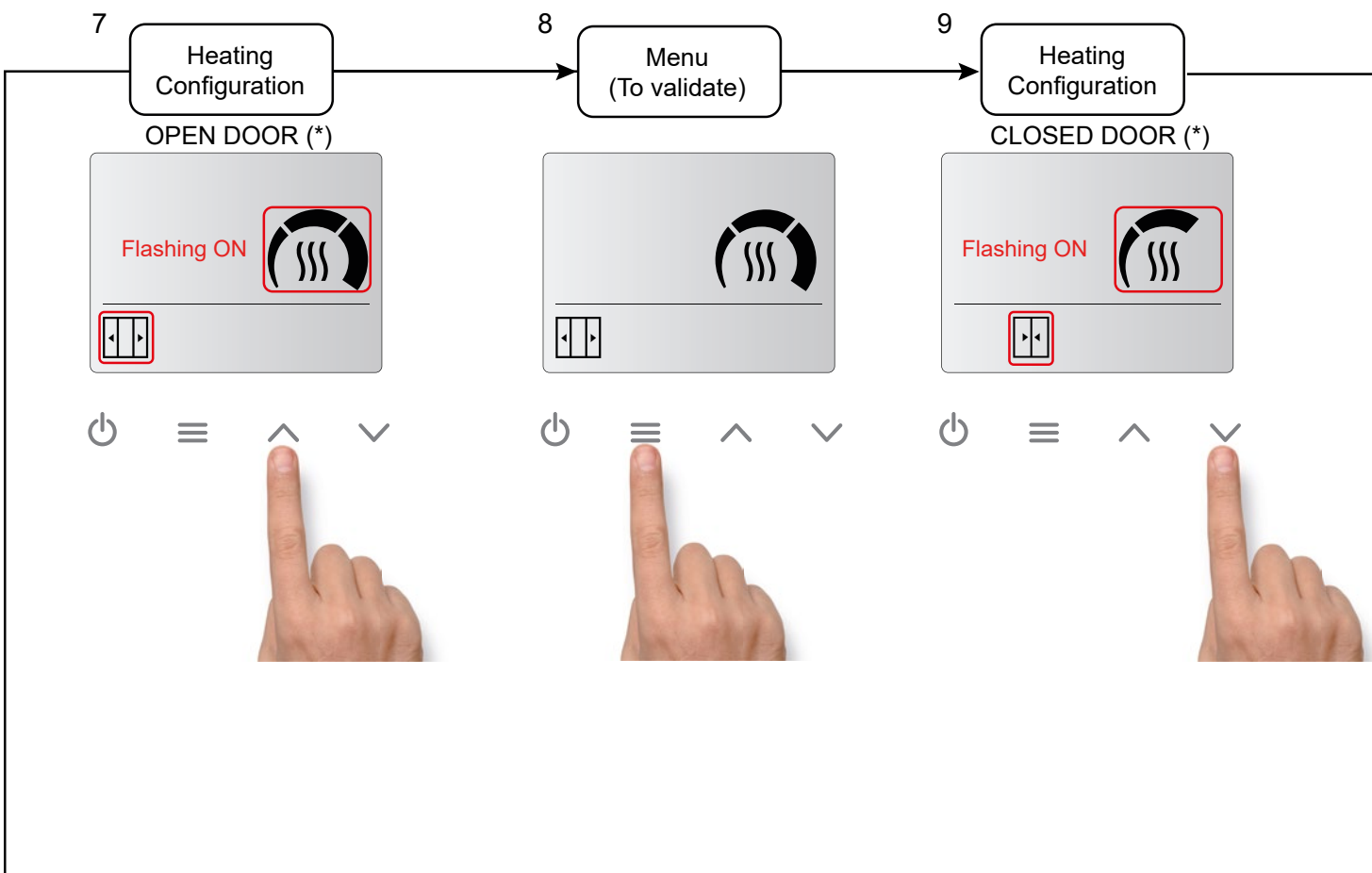

(*) If the door contact is not detected, the door open and door closed icons will not appear. Only one speed and one heating will be available.
For the door icons to appear, a door contact must be connected to the 'PCB DIN1' input and a door opening and closing cycle must be performed.

Fast access for temperature setting (only for heated models):

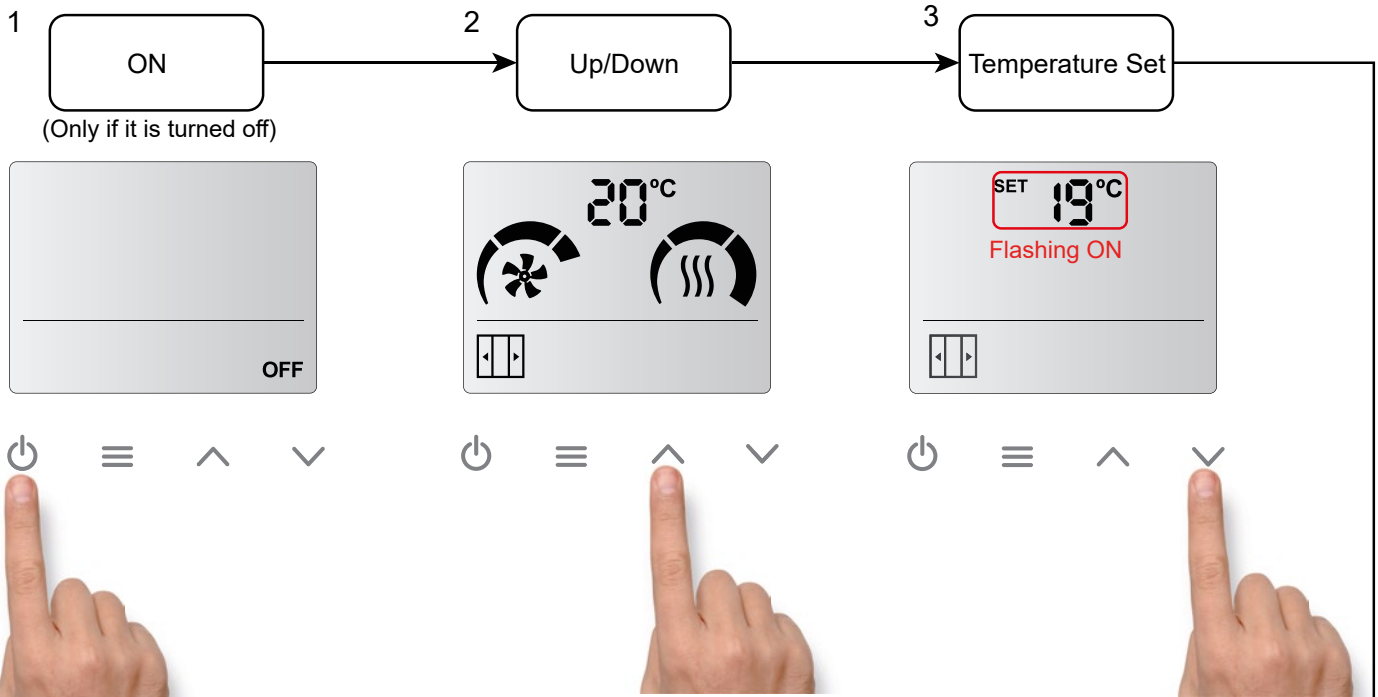

When turn on the unit or power supply is restored: if memory is ON, it will return to the configuration it had before turn off or external incident (power supply fail).

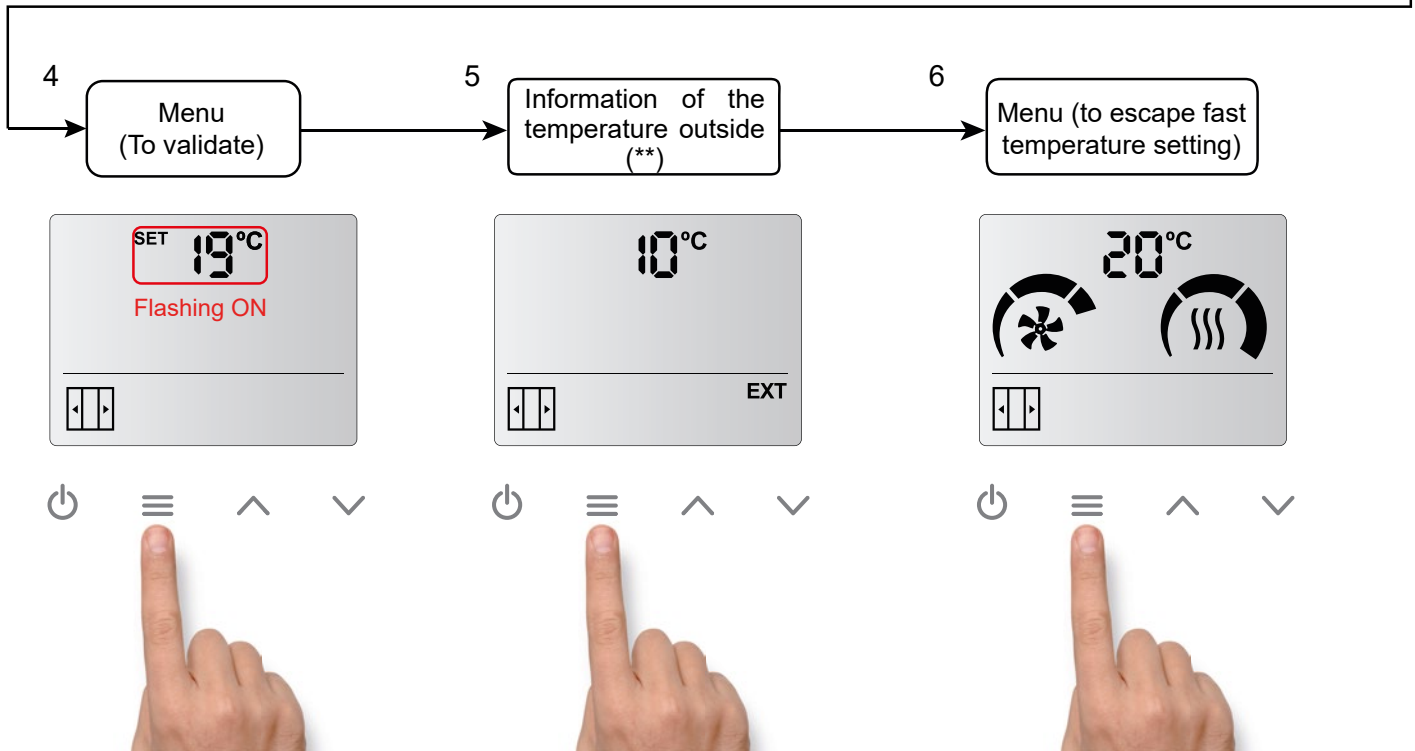

(**) Only if an outside temperature sensor is installed on the air curtain PCB.

Control Locking

The control can be locked, but the air curtain will still operate normally.
To lock the device, the user needs to press the following key combination:

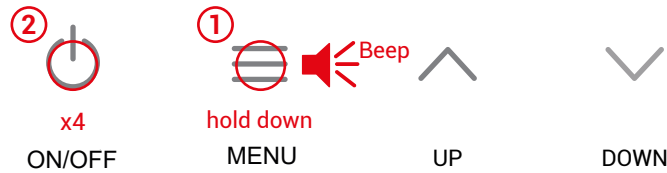

Hold down the menu button until the beep sounds and press the ON/OFF button 4 times and release the MENU button. Then a higher-pitched beeping sound will be played.

When the equipment is locked, the user will not be able to carry out any action. This limitation also applies with the remote control.

For example, when pressing the menu, a lower-pitched beep will be played indicating that the equipment is locked.

In addition, the alarm symbol shall appear on the display.

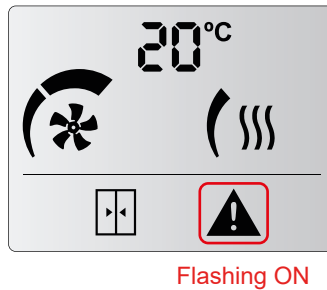

To **unlock the unit**, the user must repeat the same combination of buttons as for locking.
Then a higher-pitched beeping sound will be played, indicating that the control has been unlocked.

3. FACTORY CONFIGURATION RESET

The factory configuration reset function returns to the default values of the configuration menu, to do so:
Hold down the MENU button until the beep sounds, press alternitavely 4 times the UP and DOWN buttons, 2 times for each. The icon Fc will appear on screen.

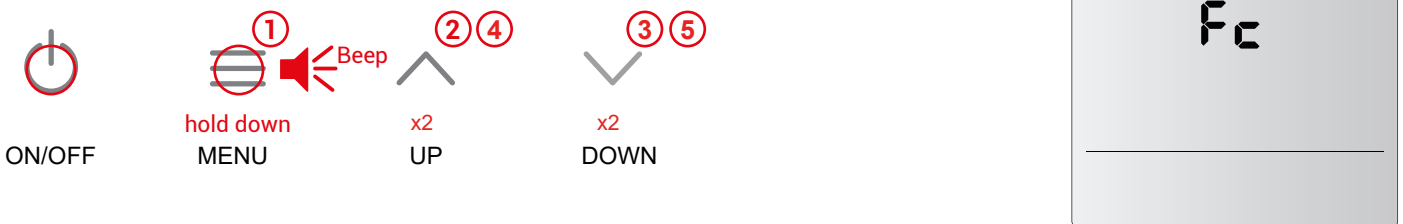

Press either the UP or the DOWN button, the Fc icon will flash on. Afterwards, hold down the ON/OFF icon for 3 seconds and you will hear 3 beep sounds to finally return to the factory configuration.

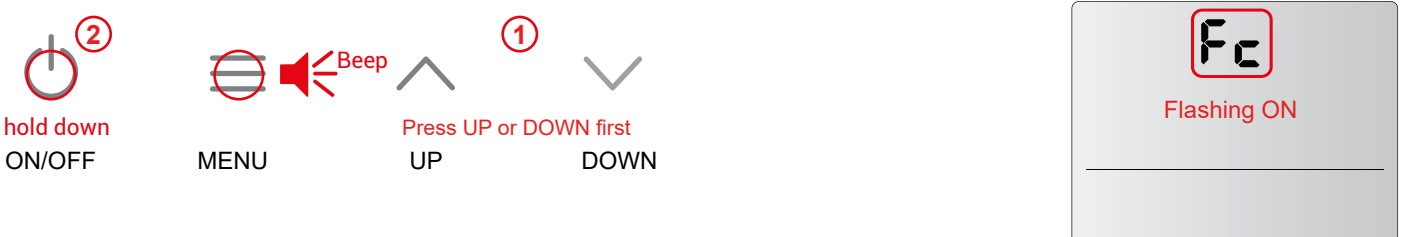

Cooling, Autocooling, External control and Boost function

Cooling:

When the discharge temperature is lower than the ambient temperature, Cooling mode starts working (flashing temperature units icon) and limits to the third fan speed. The fan icon will flash intermittently in case the set speed is higher than 3.

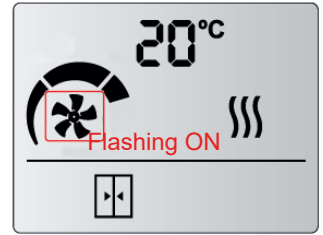

Autocooling:

Autocooling is only available for Electric heating.

If the air curtain has been running with heating for more than 10 s at a time and the user switch it off, the ventilation continues ON (at the same speed before stop the control) up to a maximum of 90 s depending on the heating working time. The ventilation speeds icons will flash intermittently and the fan icon will remain static.

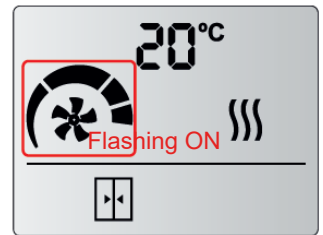

External control:

The "EXT" icon indicates that there is an external control to the unit and it is affecting the unit. There are four external signals available, depending on the program selected.

In the P1 program:

- **EXT OFF:** The unit has been stopped by External OFF contact. Not considered an alarm.
- **HEAT OFF:** Heating OFF, stopped externally. Not considered an alarm.

In the P2 program:

- **FAN EXT:** It is possible to select a fan speed when the DIN1 is closed.
- **Defrost:** The unit is set to configured speed (V1 default) for the duration of the defrost. The fan and ventilation speeds icons will flash intermittently.



EXT CONTROL OFF

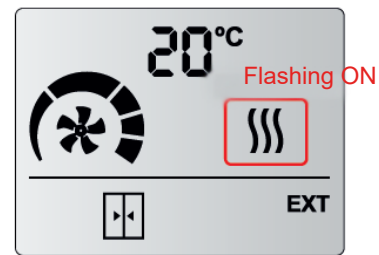

HEAT OFF

Boost Function:

The Boost function increases automatically the setpoint temperature (SET) when the door is open. For the function to be active, the door contact or the exterior sensor must be installed and, in addition, the Boost function varies according to the accessories installed:

Door contact	Exterior sensor	Boost
NO	NO	Not available
YES	NO	Open door → Always Boost *
NO	YES	Exterior temperature ≤ SET Temperature -7
YES	YES	Open door + Exterior temperature ≤ SET Temperature -7

*If you want to deactivate this function, set function 10 in the configuration menu to 0°.

Advanced Configuration

To access the advanced menu, hold down the menu button (until a beep is heard) then press the DOWN button 4 times and release the MENU button.

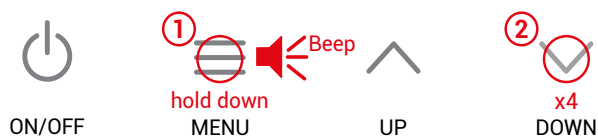

1- Door Delay (0,5,10...90)(seconds) 15 sec by default	2- Maximum speed (limit) Open Door (*)	3- Maximum speed (limit) Closed Door (*)	4- Maximum heating (limit) Open Door (*)
20 Flashing ON alternating open/closed 	02 Flashing ON 	01 Flashing ON 	03 Flashing ON
5- Maximum heating (limit) Closed Door (*)	6- Filter/maintenance (effective days) (*) (0,1,2....99) (0 days by default)	7- Celsius/Farenheit Celsius by default	8- Memory 00 - Memory OFF 01 - Memory ON (by default)
01 Flashing ON 	52 Flashing ON 	°C Flashing ON	00 Flashing ON OFF
9- Thermo FAN On by default	10- Set Boost Mode SET + x°C when door is open (+2 °C by default) (see page 11)	11- Defrost Function Only for Heat Pump air curtains	Press Button Between screens
SET °C °F ON Flashing ON 	02°C Flashing ON 	df Flashing ON 	 → ←

1- Time that the speed and heating stages remain in open door mode from the time the door contact is closed until the air curtain operates at closed door speed and heating stages.

2,3,4 and 5- Limits the ventilation and heating stages that can be selected in the user menu.

6- The numbers are sequential. If the maximum is reached, it will go back to the beginning. For example, in the *Filter/maintenance* days when the user reach 99 in case to keep going up it will go back to 0.

8- In a power failiure:

- If Memory is set as ON. Once power supply is restored, the unit will go back to work with the same parameters than before the failure.
- If Memory is set as OFF. The unit will remain switched off.

9- Thermo FAN (ON) - Ventilation ON when room temperature reaches SET temperature at closed door. Thermo FAN (OFF) - Ventilation OFF when room temperature reaches SET temperature at closed door.

(*) By default, door open/close icons are not activated. First time the door contact is closed, then it is possible to choose door open heating/ventilation and door closed heating/ventilation.

Special regulators

If there is a need to be able to control more parameters (intelligent proactive regulation, automatic/manual operation, door delay, time programmer, energy saving mode, multi-device management and BMS Modbus connection, among others) , there is one controller that allow much more possibilities than the standard controller. It has its own manual:

- Clever PRO control

Remote Control Features

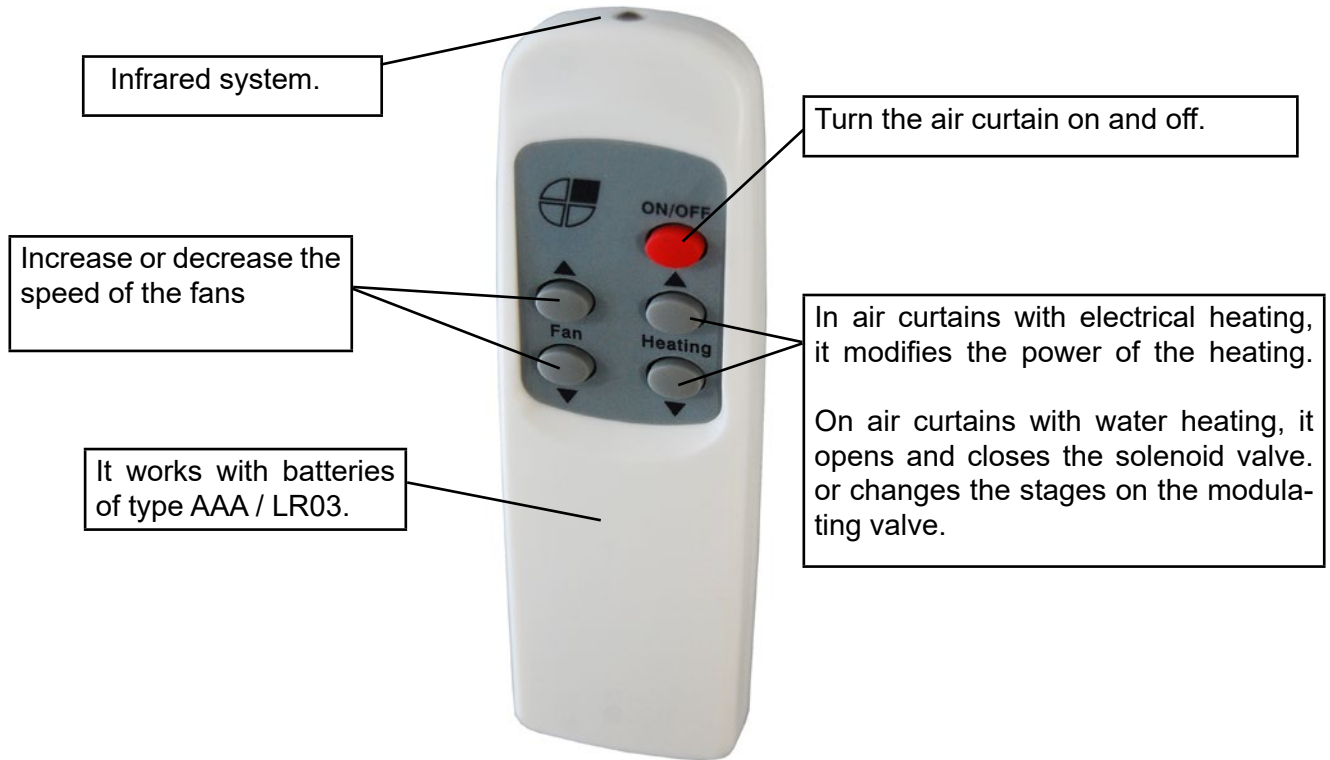

Characteristics of PCB boards

Depending on the type of fan, the air speed is regulated by:

- AC: 110 - 230 V voltage range.
- EC: from 0 - 10V DC voltage range.

All PCBs have different inputs and outputs:

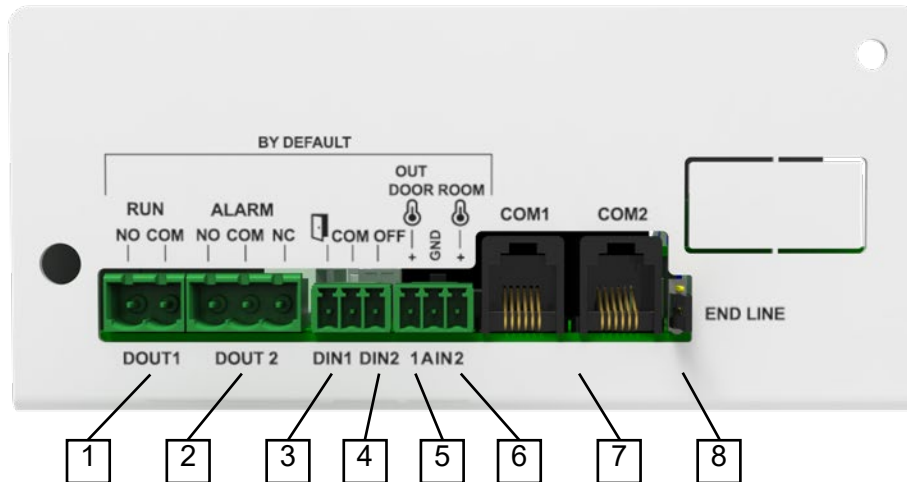

1. RUN OUT (DOUT1): Free Voltage digital output. It remains closed when the air curtain is working, it opens when the air curtain is not working.
2. ALARM SIGNAL (DOUT2): Only one of two options has to be connected, it cannot be connected simultaneously.
 - 2.1. ALARM SIGNAL (DOUT2, NO): Open when alarm signal is active.
 - 2.2. ALARM SIGNAL (DOUT2, NC): Closed when alarm signal is active.
3. DOOR CONTACT (DIN1): Free Voltage digital input. Door contact is closed when door is also closed, door contact opens consequently when door is open.
4. UNIT OFF (DIN2): Free Voltage digital input. Stops the air curtain, both heating and ventilation.
5. OUTDOOR (AIN1): Analog input for outdoor temperature sensor NTC B3950 10K at 25°C.
6. ROOM (AIN2): Analog input for room temperature sensor NTC B3950 10K at 25°C type. Once connected, it replaces Advanced PRO inbuilt sensor.

Internally the PCB has two temperature sensor connectors.

TEMP1: Replaces PCB sensor and measures outlet jet temperature.

TEMP2: Measures inlet temperature.

7. COM1/COM2: Communication port between Advanced PRO Control and other air curtains. COM1 and COM2 ports are interchangeable.
8. END LINE: When multiple air curtains are connected to one only control, the last PCB must incorporate a Jumper in "END LINE" pins.

WIRING DIAGRAMS

For the models Recessed Windbox, Recessed DAM and Recessed Compact, the following wiring diagrams are enclosed:

- Air curtain with water coil or only air (AIRDOE09080)
- Air curtain with water coil or only air SB-BB 2500 and model (AIRDOE09081)
- Electrical heated air curtains M models and G, SB 1000-1500 model (AIRDOE09084)
- Electrical heated air curtain 400Vx3 for G 2000-2500, B 2000 models (AIRDOE09085)
- Electrical heated air curtain for BB 1000 and 1500 (AIRDOE09086)
- Electrical heated air curtain for BB 2000 (AIRDOE09087)
- Electrical heated air curtain for SB-BB 2500 (AIRDOE09088)

Air curtain with water coil or only air (AIRDOE09080)

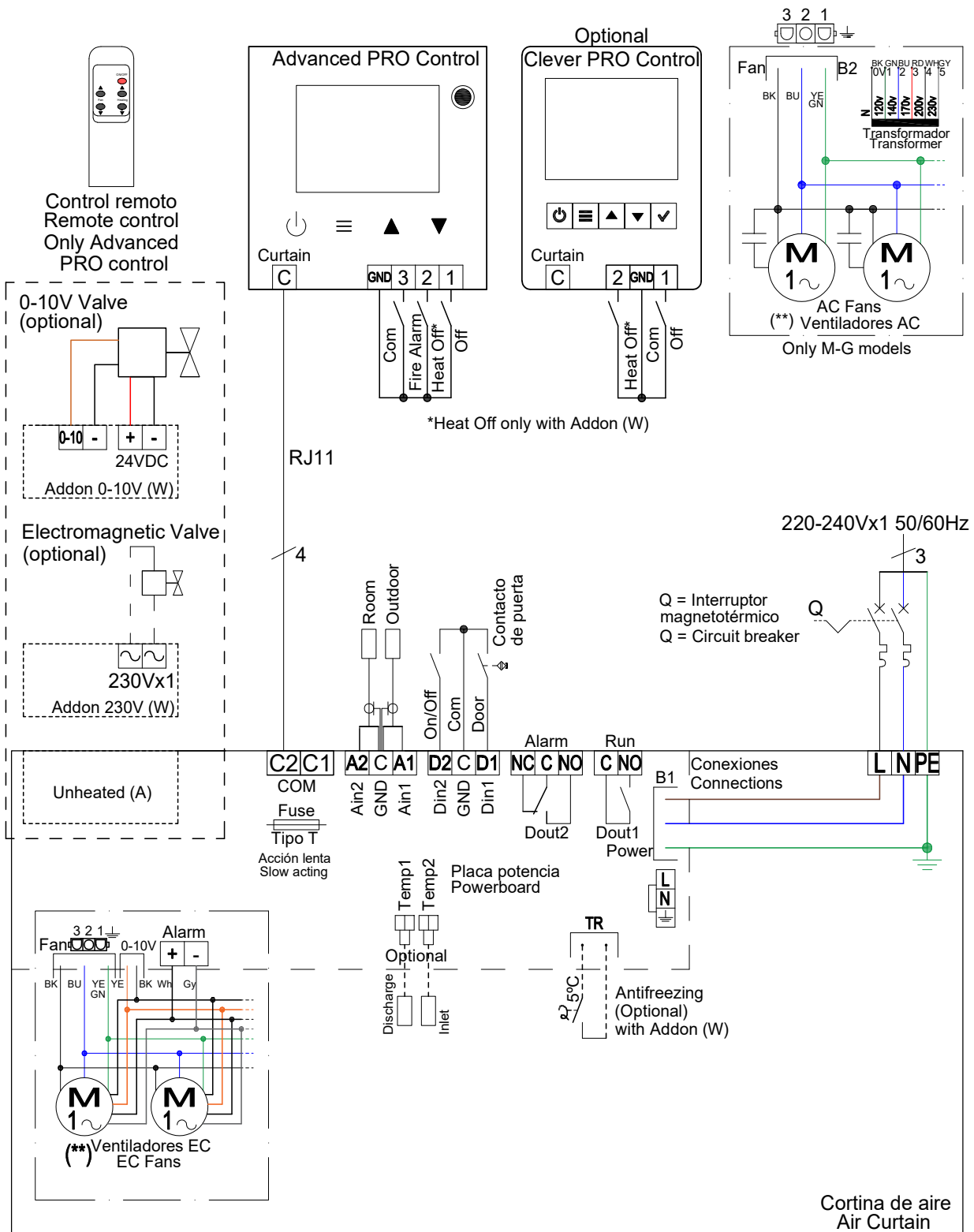

In case there is a need to connect the curtain to a PLC, the corresponding diagram is attached

Electrical heated air curtains M models and G, SB 1000-1500 models (AIRDOE09084)

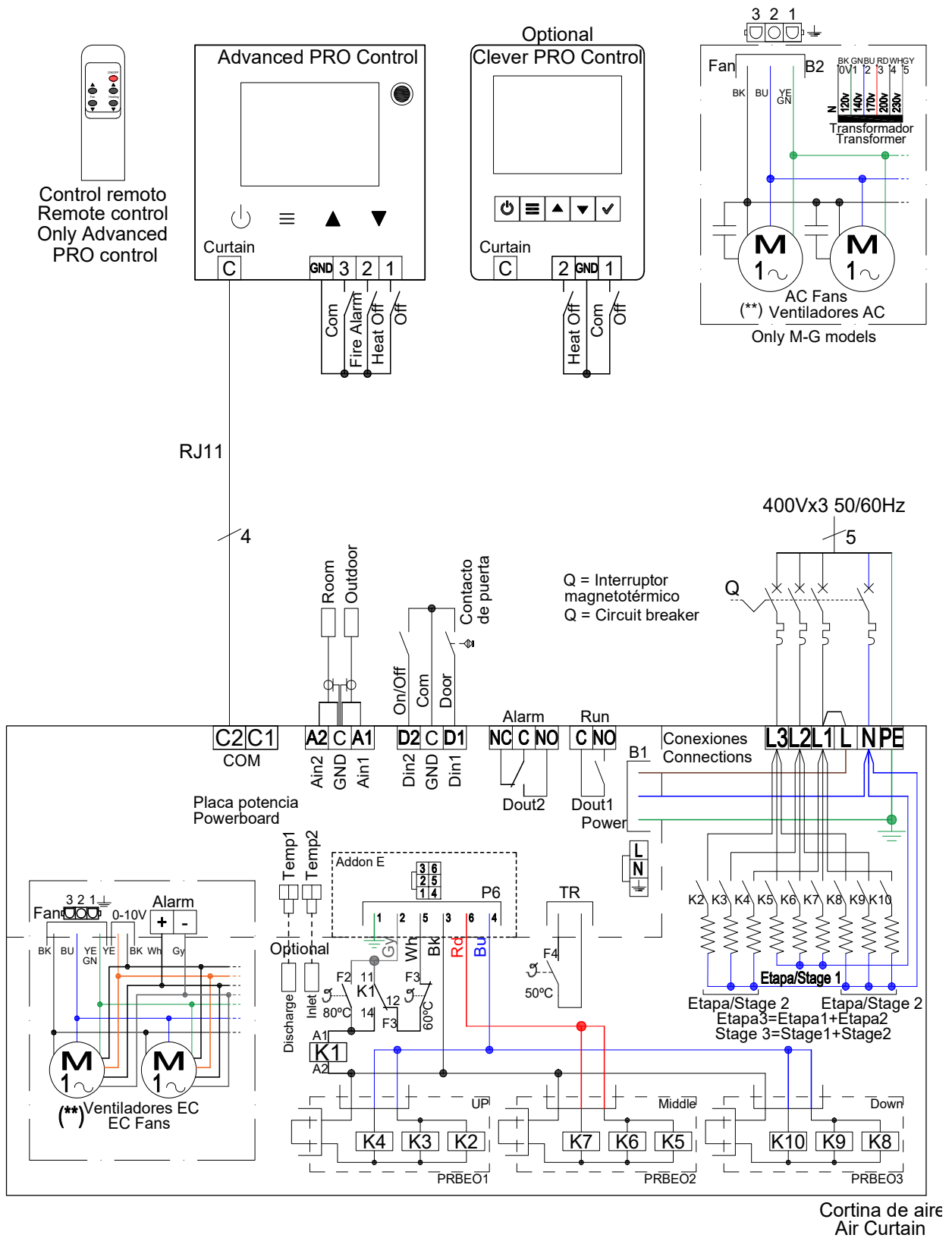

In case there is a need to connect the curtain to a PLC, the corresponding diagram is attached

Electrical heated air curtain 400Vx3 for G 2000-2500, SB 2000 models (AIRDOE09085)

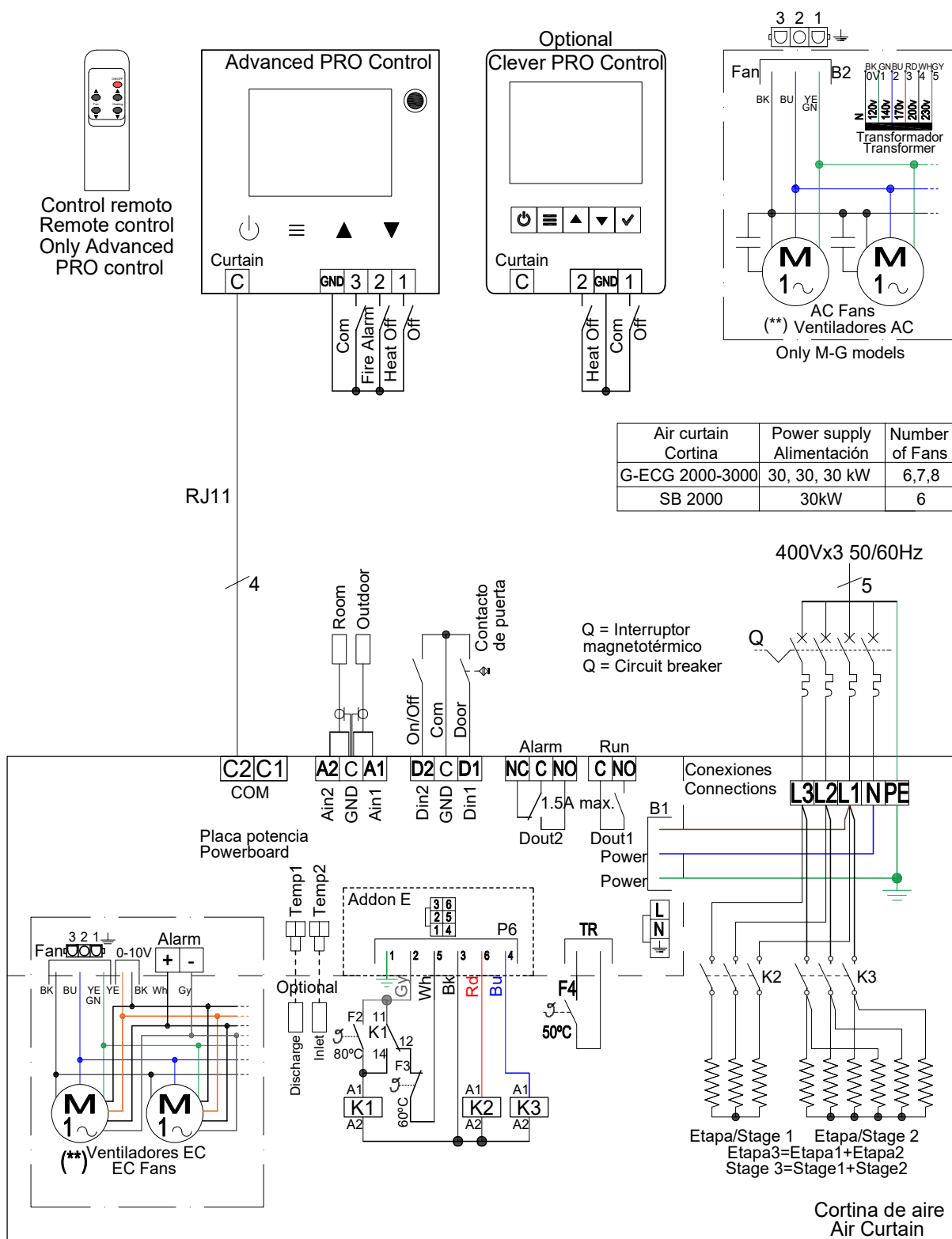

In case there is a need to connect the curtain to a PLC, the corresponding diagram is attached

Electrical heated air curtain for BB 1000 and 1500 (AIRDOE09086)

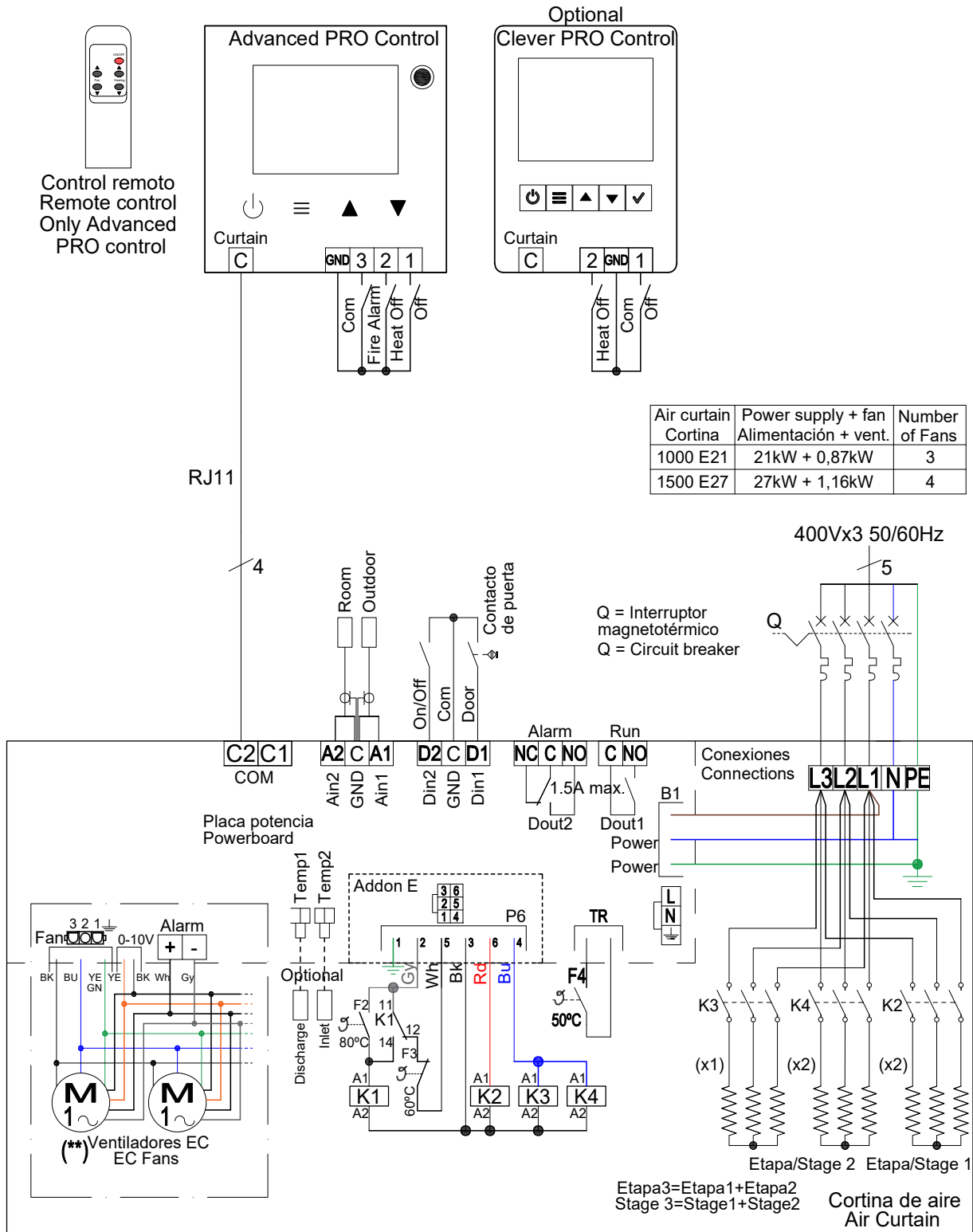

In case there is a need to connect the curtain to a PLC, the corresponding diagram is attached

Electrical heated air curtain for BB 2000 (AIRDOE09087)

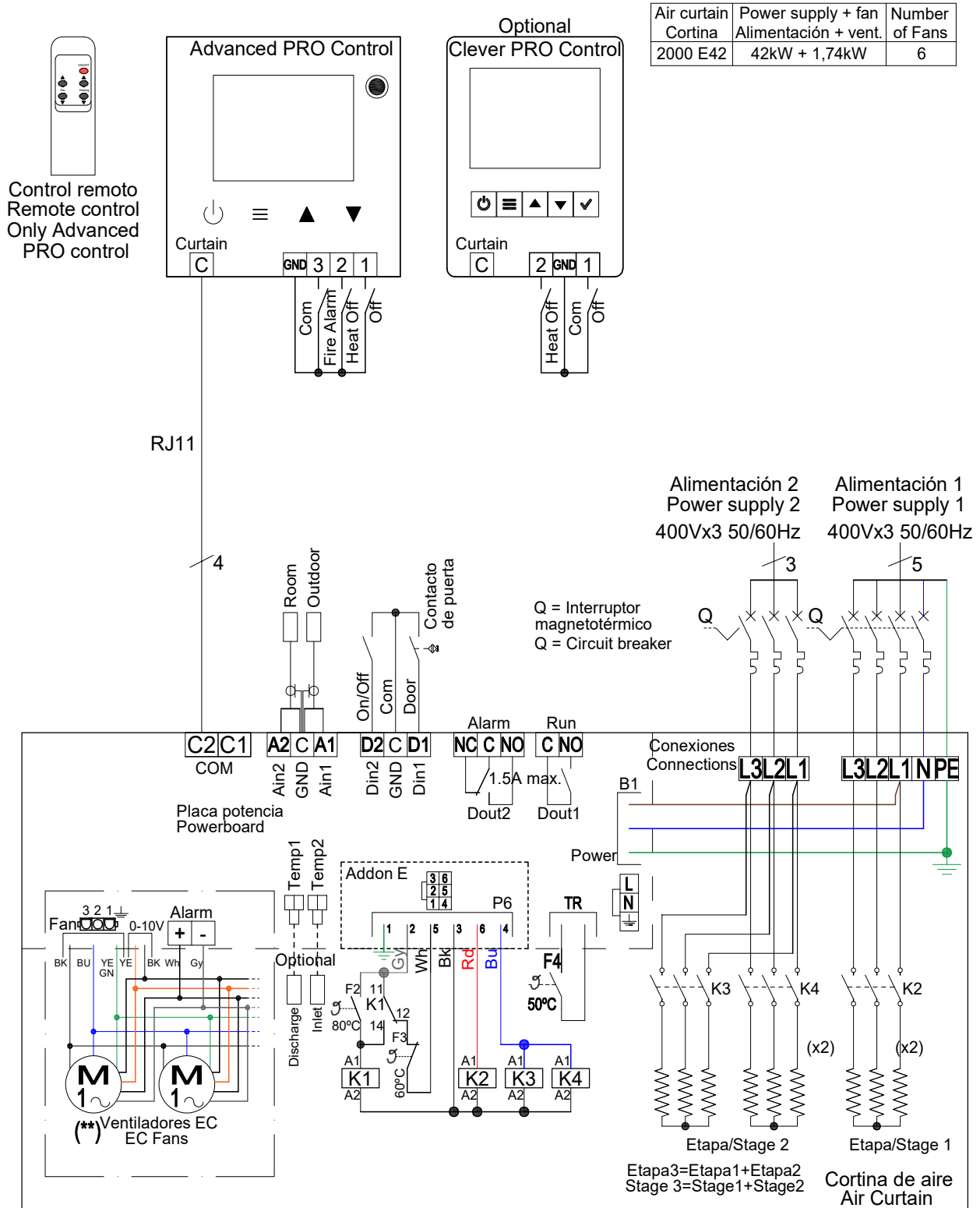

In case there is a need to connect the curtain to a PLC, the corresponding diagram is attached

Electrical heated air curtain for SB-BB 2500 (AIRDOE09088)

ESQUEMAS ELÉCTRICOS CORTINA DE AIRE VENTILADOR AC/EC
 WIRING DIAGRAMS OF AIR CURTAIN AC/EC FANS
 CONTRILHAS ELECTRICAS ELECTRO SB-2500-3000
 ELECTRICAL CONTROLLER 5 SPEEDS SB-2500-3000
 Doc. AIRDOE09088
 Pág./Page 1 de/of 1
 R02 - 12/05/25

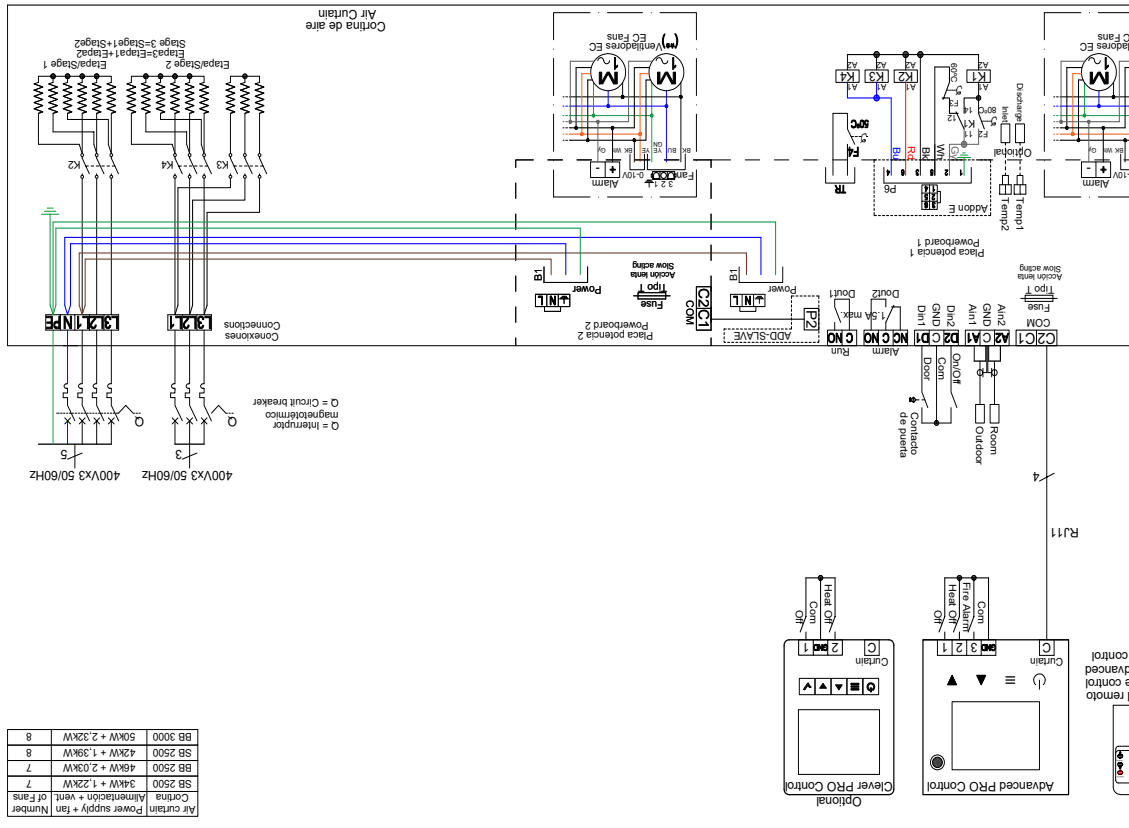

In case there is a need to connect the curtain to a PLC, the corresponding diagram is attached

RECESSED WINDBOX M,G

HIGH PRESSURE RECESSED
AIR CURTAINS FOR COMMERCIAL DOORS



Technical Features



RAL 9016
standard



Other colors
on request



Maximum range

M : 3,5 m ECM : 3,8 m
G : 4 m ECG : 4,2 m



Airflow / Length

1660 - 6300 m³/h
1 m to 2,5 m



Fans

Centrifugal
5-speed



Heating types

E : electrical 3 stages
P : water
A : unheated
DX : heat pump [*]



Heating capacity

E : 3 - 30 kW
P : 8,5 - 33,6 kW



Control

Plug&Play Advanced PRO
+ IR remote control
(Optional Clever Control)



Casing

Galvanised Steel



Grille type

Suction lamellas



Outlet lamellas

Aluminium, airfoil type
Adjustable 0-15° each side

[*] Consult separate DX catalogs

RECESSED WINDBOX is a high pressure compact and robust air curtain from our standard range with a timeless and visually pleasing design. It is specially designed for recessed installation in false ceilings. It is a suitable air curtain for all types of commercial entrances. Inlet grille made with aluminium profiles and blow-out nozzle, integrated in a single white frame colour RAL 9016. Other colours are available on request.

This air curtain model works with double-inlet centrifugal fans driven by an external rotor motor with low noise level. EC models assembled with very low consumption efficiency fans.

Advanced Plug&Play control. Includes: Advanced PRO control with LCD display and integrated thermostat, door contact, 7m RJ11 cable and remote control. Optional: intelligent Clever PRO Control (automatic, programmable, modbus for PLC, timer, etc).

✿ UNHEATED

Model	Airflow m³/h	Ventilation power 230V~50Hz kW	Ventilation current 230V~50Hz A	Noise level (5 m) dB(A)	Weight kg
RM 1000 A	1800	0,212	0,94	55	57
RM 1500 A	2700	0,318	1,41	56	85
RM 2000 A	3600	0,424	1,88	57	109
RM 2500 A	4500	0,530	2,35	58	137
RECM 1000 A	1840	0,142	1,24	56	57
RECM 1500 A	2760	0,213	1,86	57	85
RECM 2000 A	3680	0,284	2,48	58	109
RECM 2500 A	4600	0,355	3,10	59	137
RG 1000 A	2400	0,642	2,85	57	61
RG 1500 A	3200	0,856	3,80	58	90
RG 2000 A	4800	1,284	5,70	59	118
RG 2500 A	5600	1,498	6,65	60	145
RECG 1000 A	2700	0,213	1,86	61	61
RECG 1500 A	3600	0,284	2,48	62	90
RECG 2000 A	5400	0,426	3,72	63	118
RECG 2500 A	6300	0,497	4,34	64	145



 ELECTRIC HEATED

Model	Airflow	Electrical heating capacity 400Vx3~50Hz (*)	Ventilation power 230V~50Hz	Ventilation current 230V~50Hz	Noise level (5 m)	Weight
	m ³ /h	kW	kW	A	dB(A)	kg
RM 1000 E	1800	3/6/9	0,212	0,94	55	65
RM 1500 E	2700	4/8/12	0,318	1,41	56	98
RM 2000 E	3600	6/12/18	0,424	1,88	57	130
RM 2500 E	4500	6/12/18	0,530	2,35	58	162
RECM 1000 E	1840	3/6/9	0,142	1,24	56	65
RECM 1500 E	2760	4/8/12	0,213	1,86	57	98
RECM 2000 E	3680	6/12/18	0,284	2,48	58	130
RECM 2500 E	4600	6/12/18	0,355	3,10	59	162
RG 1000 E	2400	5/10/15	0,642	2,85	57	70
RG 1500 E	3200	7,5/15/22,5	0,856	3,80	58	104
RG 2000 E	4800	10/20/30	1,284	5,70	59	140
RG 2500 E	5600	10/20/30	1,498	6,65	60	172
RECG 1000 E	2700	5/10/15	0,213	1,86	61	70
RECG 1500 E	3600	7,5/15/22,5	0,284	2,48	62	104
RECG 2000 E	5400	10/20/30	0,426	3,72	63	140
RECG 2500 E	6300	10/20/30	0,497	4,34	64	172

(*) Under request other electrical heating power can be limited.

 WATER HEATED

Model	Airflow m ³ /h	P86 (80/60°C)		P64 (60/40°C)		P54 (50/40°C)		Ventilation power 230V~50Hz kW	Ventilation current 230V~50Hz A	Noise level (5 m) dB(A)	Weight kg
		Water heating capacity kW	Water pressure drop Pa	Water heating capacity kW	Water pressure drop Pa	Water heating capacity kW	Water pressure drop Pa				
RM 1000 P	1660	9,17	880	8,56	4370	8,52	1220	0,428	1,90	56	63
RM 1500 P	2490	14,26	760	13,69	6460	14,34	4480	0,642	2,85	57	93
RM 2000 P	3320	20,65	1930	18,26	4790	18,65	2060	0,856	3,80	58	122
RM 2500 P	4150	26,92	3810	22,12	3850	24,32	4040	1,070	4,75	59	153
RECM 1000 P	1720	9,38	920	8,77	4560	8,74	1280	0,142	1,24	56	63
RECM 1500 P	2580	14,58	790	14,02	6730	14,71	4690	0,213	1,86	57	93
RECM 2000 P	3440	21,12	2010	18,70	4990	19,13	2150	0,284	2,48	58	122
RECM 2500 P	4300	27,53	3960	23,33	4010	24,95	4230	0,355	3,10	59	153
RG 1000 P	2250	11,04	1230	10,42	6190	10,56	1790	0,642	2,85	57	67
RG 1500 P	3000	16,02	940	15,47	8020	16,37	5670	0,856	3,80	58	98
RG 2000 P	4500	24,92	2700	22,29	6810	23,15	3030	1,284	5,70	59	131
RG 2500 P	5250	31,16	4930	26,61	5060	28,76	5450	1,498	6,65	60	163
RECG 1000 P	2550	11,89	1400	11,27	7110	11,50	2090	0,213	1,86	61	67
RECG 1500 P	3400	17,29	1070	16,77	9240	17,86	6620	0,284	2,48	62	98
RECG 2000 P	5100	26,86	3080	24,14	7850	25,24	3530	0,426	3,72	63	131
RECG 2500 P	5950	33,63	5650	28,84	5840	31,38	6360	0,497	4,34	64	163

Water heated: connection pipes P86 and P64 are 2x3/4" female (male if lateral pipes), P54 2x1" male.
P86 2 rows coil, P64 3 rows coil, P54 4 rows coil.





Dimensions

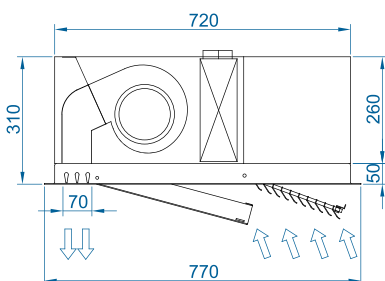
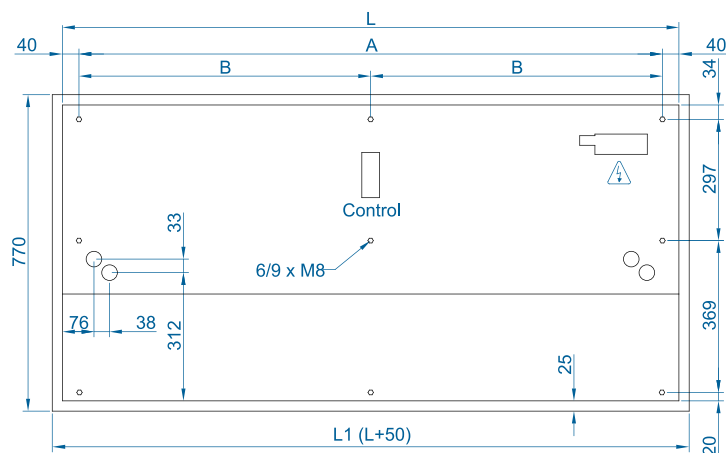

	L	L ¹	A	B
RWIN 1000	1000	1050	920	-
RWIN 1500	1500	1550	1420	710
RWIN 2000	2000	2050	1920	960
RWIN 2500	2500	2550	2420	1210

Optional accessories

CAD drawings, BIM files, installation manuals and other documentation



Supports and installation



Wall rail support
SPWR



Silentblock supports
SPANG-SIL / SLB



Suspension cables
SPCT

Control



ADVANCED PRO
✓ Included



IR Control
✓ Included



RJ11 Cable
✓ Included



CLEVER PRO

Filters



Removable
prefilter G2

Sensors and valves



Magnetic
door contact MAG-DC
✓ Included



Mechanical
door contact MEC-DC



External Temperature
Sensor



Solenoid valve
V-S



Valve 3 ways
V-T



Proportional valve
V-ACT



Anti-freezing sensor
AFS-INS

Condensation



Condensation tray



Technical Features



RAL 9016
standard



Other colors
on request



Maximum range

M : 3,5 m ECM : 3,8 m
G : 4 m ECG : 4,2 m



Airflow / Length

1660 - 6300 m³/h
1 m to 2,5 m



Fans

Centrifugal
5-speed



Heating types

E : electrical 3 stages
P : water
A : unheated
DX : heat pump [+]



Heating capacity

E : 3 - 30 kW
P : 8,5 - 33,6 kW



Control

Plug&Play Advanced PRO
+ IR remote control
(Optional Clever Control)



Casing

Galvanised Steel



Grille type

Suction lamellas +
Rectangular perforated



Outlet lamellas

Aluminium

[+] Consult separate DX catalogs

RECESSED DAM is a high pressure compact and low profile air curtain from our standard range. It is specially designed for recessed installation in false ceilings, suitable for all types of commercial entrances. Its design is characterized by providing a full view of the inlet and outlet slatted grille, which is maintenance-free and is completely integrated into a single frame colour RAL 9016. Other colours are available on request.

This air curtain model works with double-inlet centrifugal fans driven by an external rotor motor with low noise level. EC models assembled with very low consumption efficiency fans.

Advanced Plug&Play control. Includes: Advanced PRO control with LCD display and integrated thermostat, door contact, 7m RJ11 cable and remote control. Optional: intelligent Clever PRO Control (automatic, programmable, modbus for PLC, timer, etc).

❄ UNHEATED

Model	Airflow	Ventilation power	Ventilation current	Noise level	Weight
	m³/h	230V~50Hz kW	230V~50Hz A	(5 m) dB(A)	
RDAM M 1000 A	1800	0,212	0,94	55	45
RDAM M 1500 A	2700	0,318	1,41	56	66
RDAM M 2000 A	3600	0,424	1,88	57	84
RDAM M 2500 A	4500	0,530	2,35	58	93
RDAM ECM 1000 A	1840	0,142	1,24	56	45
RDAM ECM 1500 A	2760	0,213	1,86	57	66
RDAM ECM 2000 A	3680	0,284	2,48	58	84
RDAM ECM 2500 A	4600	0,355	3,10	59	93
RDAM G 1000 A	2400	0,642	2,85	57	49
RDAM G 1500 A	3200	0,856	3,80	58	71
RDAM G 2000 A	4800	1,284	5,70	59	94
RDAM G 2500 A	5600	1,498	6,65	60	103
RDAM ECG 1000 A	2700	0,213	1,86	61	49
RDAM ECG 1500 A	3600	0,284	2,48	62	71
RDAM ECG 2000 A	5400	0,426	3,72	63	94
RDAM ECG 2500 A	6300	0,497	4,34	64	103



 ELECTRIC HEATED

Model	Airflow	Electrical heating capacity 400Vx3~50Hz (*)	Ventilation power 230V~50Hz	Ventilation current 230V~50Hz	Noise level (5 m)	Weight
	m ³ /h	kW	kW	A	dB(A)	kg
RDAM M 1000 E	1800	3/6/9	0,212	0,94	55	52
RDAM M 1500 E	2700	4/8/12	0,318	1,41	56	78
RDAM M 2000 E	3600	6/12/18	0,424	1,88	57	102
RDAM M 2500 E	4500	6/12/18	0,530	2,35	58	113
RDAM ECM 1000 E	1840	3/6/9	0,142	1,24	56	52
RDAM ECM 1500 E	2760	4/8/12	0,213	1,86	57	78
RDAM ECM 2000 E	3680	6/12/18	0,284	2,48	58	102
RDAM ECM 2500 E	4600	6/12/18	0,355	3,10	59	113
RDAM G 1000 E	2400	5/10/15	0,642	2,85	57	57
RDAM G 1500 E	3200	7,5/15/22,5	0,856	3,80	58	84
RDAM G 2000 E	4800	10/20/30	1,284	5,70	59	112
RDAM G 2500 E	5600	10/20/30	1,498	6,65	60	123
RDAM ECG 1000 E	2700	5/10/15	0,213	1,86	61	57
RDAM ECG 1500 E	3600	7,5/15/22,5	0,284	2,48	62	84
RDAM ECG 2000 E	5400	10/20/30	0,426	3,72	63	112
RDAM ECG 2500 E	6300	10/20/30	0,497	4,34	64	123

(*) Under request other electrical heating power can be limited.

 WATER HEATED

Model	Airflow m ³ /h	P86 (80/60°C)		P64 (60/40°C)		P54 (50/40°C)		Ventilation power 230V~50Hz kW	Ventilation current 230V~50Hz A	Noise level (5 m) dB(A)	Weight kg
		Water heating capacity kW	Water pressure drop Pa	Water heating capacity kW	Water pressure drop Pa	Water heating capacity kW	Water pressure drop Pa				
RDAM M 1000 P	1660	9,17	880	8,56	4370	8,52	1220	0,428	1,90	56	50
RDAM M 1500 P	2490	14,26	760	13,69	6460	14,34	4480	0,642	2,85	57	74
RDAM M 2000 P	3320	20,65	1930	18,26	4790	18,65	2060	0,856	3,80	58	95
RDAM M 2500 P	4150	26,92	3810	22,12	3850	24,32	4040	1,070	4,75	59	106
RDAM ECM 1000 P	1720	9,38	920	8,77	4560	8,74	1280	0,142	1,24	56	50
RDAM ECM 1500 P	2580	14,58	790	14,02	6730	14,71	4690	0,213	1,86	57	74
RDAM ECM 2000 P	3440	21,12	2010	18,70	4990	19,13	2150	0,284	2,48	58	95
RDAM ECM 2500 P	4300	27,53	3960	23,33	4010	24,95	4230	0,355	3,10	59	106
RDAM G 1000 P	2250	11,04	1230	10,42	6190	10,56	1790	0,642	2,85	57	55
RDAM G 1500 P	3000	16,02	940	15,47	8020	16,37	5670	0,856	3,80	58	80
RDAM G 2000 P	4500	24,92	2700	22,29	6810	23,15	3030	1,284	5,70	59	105
RDAM G 2500 P	5250	31,16	4930	26,61	5060	28,76	5450	1,498	6,65	60	114
RDAM ECG 1000 P	2550	11,89	1400	11,27	7110	11,50	2090	0,213	1,86	61	55
RDAM ECG 1500 P	3400	17,29	1070	16,77	9240	17,86	6620	0,284	2,48	62	80
RDAM ECG 2000 P	5100	26,86	3080	24,14	7850	25,24	3530	0,426	3,72	63	105
RDAM ECG 2500 P	5950	33,63	5650	28,84	5840	31,38	6360	0,497	4,34	64	114

Water heated: connection pipes P86 and P64 are 2x3/4" female (male if lateral pipes), P54 2x1" male.
P86 2 rows coil, P64 3 rows coil, P54 4 rows coil.



Selection program



Dimensions

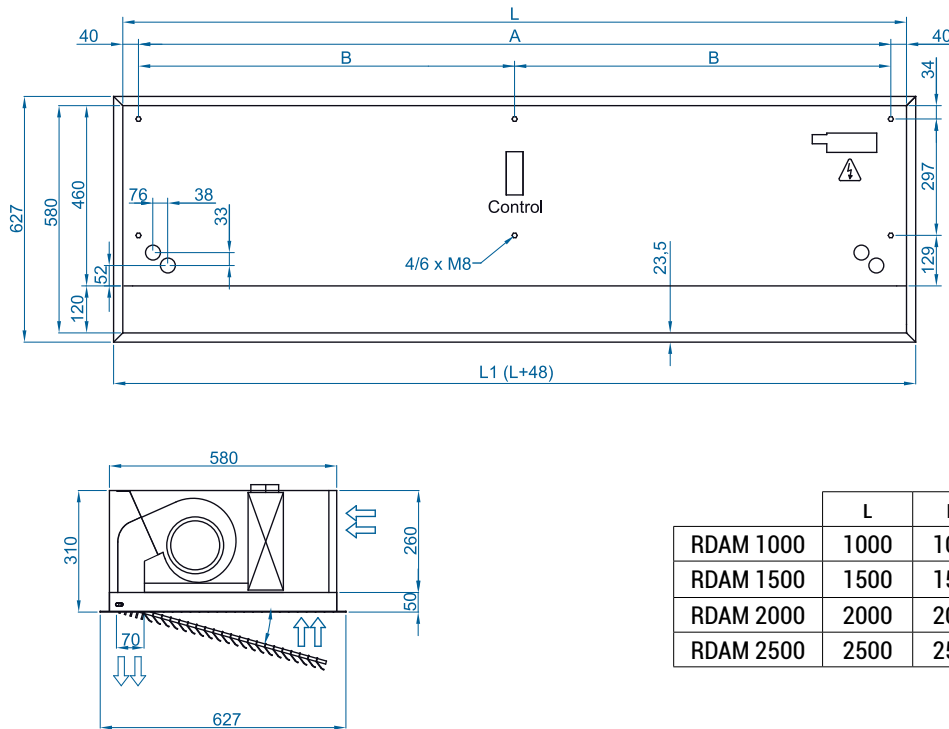

	L	L1	A	B
RDAM 1000	1000	1050	920	-
RDAM 1500	1500	1550	1420	710
RDAM 2000	2000	2050	1920	960
RDAM 2500	2500	2550	2420	1210

Optional accessories

CAD drawings, BIM files, installation manuals and other documentation



Supports and installation



Wall rail support
SPWR



Silentblock supports
SPANG-SIL / SLB



Suspension cables
SPCT

Control



ADVANCED PRO
✓ Included



IR Control
✓ Included



RJ11 Cable
✓ Included



CLEVER PRO

Filters



Removable
prefilter G2

Sensors and valves



Magnetic
door contact MAG-DC
✓ Included



Mechanical
door contact MEC-DC



External Temperature
Sensor



Solenoid valve
V-S



Valve 3 ways
V-T



Proportional valve
V-ACT



Anti-freezing sensor
AFS-INS

Condensation



Condensation tray



Technical Features



RAL 9016
standard



Other colors
on request



Maximum range

M : 3,5 m ECM : 3,8 m
G : 4 m ECG : 4,2 m



Airflow / Length

1800 - 6300 m³/h
1 m to 2,5 m



Fans

Centrifugal
5-speed



Heating types

A: unheated



Heating capacity

-



Control

Plug&Play Advanced PRO
+ IR remote control
(Optional Clever Control)



Casing

Galvanised Steel



Grille type

Suction lamellas



Outlet lamellas

Aluminium

RECESSED COMPACT air curtain is specially designed for non-heating applications. This recessed low profile model has a diffuser grille with an integral view, and a self-supporting frame for installation in false ceilings. Its design is characterized by providing a full view of the inlet and outlet slatted grille, which is maintenance-free and is completely integrated into a single frame colour RAL 9016 Other colours are available on request. This air curtain model works with double-inlet centrifugal fans driven by an external rotor motor with low noise level. EC models assembled with very low consumption efficiency fans.

Advanced Plug&Play control. Includes: Advanced PRO control with LCD display and integrated thermostat, door contact, 7m RJ11 cable and remote control. Optional: intelligent Clever PRO Control (automatic, programmable, modbus for PLC, timer, etc).

❄️ UNHEATED

Model	Airflow	Ventilation power	Ventilation current	Noise level	Weight
	m³/h	230V~50Hz kW	230V~50Hz A	(5 m) dB(A)	
CR M 1000 A	1800	0,212	0,94	55	33
CR M 1500 A	2700	0,318	1,41	56	50
CR M 2000 A	3600	0,424	1,88	57	61
CR M 2500 A	4500	0,530	2,35	58	68
CR ECM 1000 A	1840	0,142	1,24	56	33
CR ECM 1500 A	2760	0,213	1,86	57	50
CR ECM 2000 A	3680	0,284	2,48	58	61
CR ECM 2500 A	4600	0,355	3,10	59	68
CR G 1000 A	2400	0,642	2,85	57	37
CR G 1500 A	3200	0,856	3,80	58	55
CR G 2000 A	4800	1,284	5,70	59	71
CR G 2500 A	5600	1,498	6,65	60	78
CR ECG 1000 A	2700	0,213	1,86	61	37
CR ECG 1500 A	3600	0,284	2,48	62	56
CR ECG 2000 A	5400	0,426	3,72	63	71
CR ECG 2500 A	6300	0,497	4,34	64	78





Dimensions

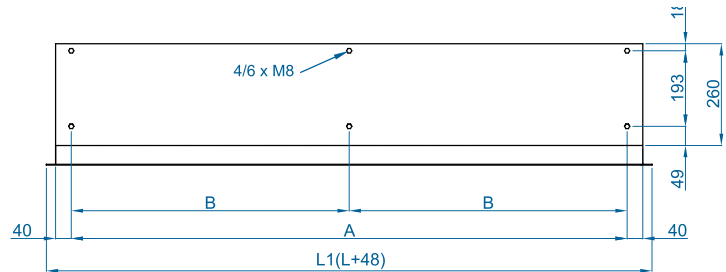
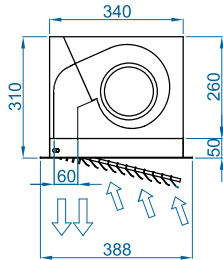

	L	L1	A	B
RC 1000	1000	1048	920	-
RC 1500	1500	1548	1420	710
RC 2000	2000	2048	1920	960
RC 2500	2500	2548	2420	1210

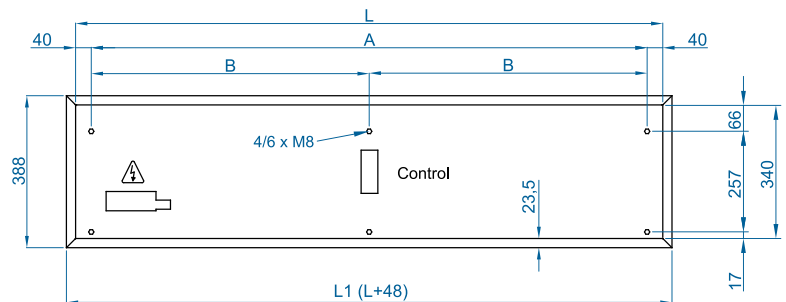

CAD drawings, BIM files, installation manuals and other documentation



Optional accessories

Supports and installation



Wall rail supports
SPWR



Silentblock supports
SPANG-SIL / SLB



Suspension cables
SPCT

Control



ADVANCED PRO
✓ Included



IR Control
✓ Included



RJ11 Cable
✓ Included



CLEVER PRO

Sensors



Mechanical door contact
MEC-DC



Magnetic door contact
MAG-DC
✓ Included



External Temperature
Sensor



Technical Features



Maximum range
SB : 5 m BB : 7 m



Airflow / Length
**2910 - 9380 m³/h
1 m to 2,5 m**



Fans
**Centrifugal
5-speed**



Heating types
**E : electrical 3 stages
P : water
A : unheated
DX : heat pump [*]**



Heating capacity
**E : 5 - 46 kW
P : 12,4 - 45,8 kW**



Control
**Plug&Play Advanced PRO
+ IR remote control
(Optional Clever Control)**



Casing
Galvanised Steel



Grille type
**Suction lamellas +
Rectangular perforated**



Outlet lamellas
**Aluminium, airfoil type
Adjustable 0-15° each side**

RAL 9016
standard



Other colors
on request



Stainless
steel



[*] Consult separate DX catalogs

RECESSED WINDBOX SB-BB is a high pressure compact and robust air curtain from our standard range with a timeless design, for recessed installation in false ceilings. It is a suitable air curtain for all types of commercial and industrial entrances.

Inlet grille made with aluminium profiles and blow-out nozzle, integrated in a single white frame colour RAL 9016. Other colours are available on request.

This model works with the latest generation of double-inlet centrifugal high efficiency EC fans driven by an external rotor motor, with low noise level and very low consumption.

Advanced Plug&Play control. Includes: Advanced PRO control with LCD display and integrated thermostat, door contact, 7m RJ11 cable and remote control. Optional: intelligent Clever PRO Control (automatic, programmable, modbus for PLC, timer, etc).

* UNHEATED

Model	Airflow m³/h	Ventilation power 230V~50Hz kW	Ventilation current 230V~50Hz A	Noise level (5 m) dB(A)	Weight kg
RSB 1000 A	3060	0,523	3,8	62	48
RSB 1500 A	4080	0,697	5,07	63	73
RSB 2000 A	6120	1,046	7,61	64	97
RSB 2500 A	7140	1,22	8,87	65	121
RBB 1000 A	4020	0,873	3,87	66	50
RBB 1500 A	5360	1,164	5,16	67	75
RBB 2000 A	8040	1,746	7,74	68	100
RBB 2500 A	9380	2,037	9,03	69	125



⚡ ELECTRIC HEATED

Model	Airflow	Electrical heating capacity 400Vx3~50Hz (*)	Ventilation power 230V~50Hz	Ventilation current 230V~50Hz	Noise level (5 m)	Weight
	m ³ /h	kW	kW	A	dB(A)	
RSB 1000 E	3060	5/10/15	0,523	3,8	62	58
RSB 1500 E	4080	7,5/15/22,5	0,697	5,07	63	89
RSB 2000 E	6120	10/20/30	1,046	7,61	64	118
RSB 2500 E	7140	12/22/34 (**)	1,22	8,87	65	147
RBB 1000 E	4020	6/15/21	0,873	3,87	66	60
RBB 1500 E	5360	8/19/27	1,164	5,16	67	91
RBB 2000 E	8040	12/30/42 (**)	1,746	7,74	68	121
RBB 2500 E	9380	16/30/46 (**)	2,037	9,03	69	151

(*) Under request other electrical heating power can be limited.

(**) 2 separated power supplies.

💧 WATER HEATED

Model	Airflow m ³ /h	P86 (80/60°C)		P64 (60/40°C)		P54 (50/40°C)		Ventilation power 230V~50Hz kW	Ventilation current 230V~50Hz A	Noise level (5 m) dB(A)	Weight kg
		Water heating capacity kW	Water pressure drop Pa	Water heating capacity kW	Water pressure drop Pa	Water heating capacity kW	Water pressure drop Pa				
RSB 1000 P	2910	15,58	8280	12,44	8640	14,47	9820	0,523	3,8	62	56
RSB 1500 P	3880	19,71	630	18,55	5840	21,19	12380	0,697	5,07	63	86
RSB 2000 P	5820	31	1860	25,84	4580	30,77	10270	1,046	7,61	64	114
RSB 2500 P	6790	38,97	3440	31,79	7160	36,94	9570	1,22	8,87	65	142
RBB 1000 P	3750	18,21	15190	15,16	16190	16,48	12180	0,873	3,87	65	58
RBB 1500 P	5000	23,52	1200	21,87	10990	24,15	15260	1,164	5,16	66	88
RBB 2000 P	7500	36,57	3470	31,13	7350	35,04	12680	1,746	7,74	67	117
RBB 2500 P	8750	45,78	6370	38,96	13420	42,12	11880	2,037	9,03	68	146

Water heated:

P86, P64 2x1", P54 1000-2000 2x1" and 2500 2x1 ¼".

Connection pipes P86, P64 and P54 are male.

P86 2 rows coil, P64 3 rows coil, P54 4 rows coil.



Selection program



Dimensions

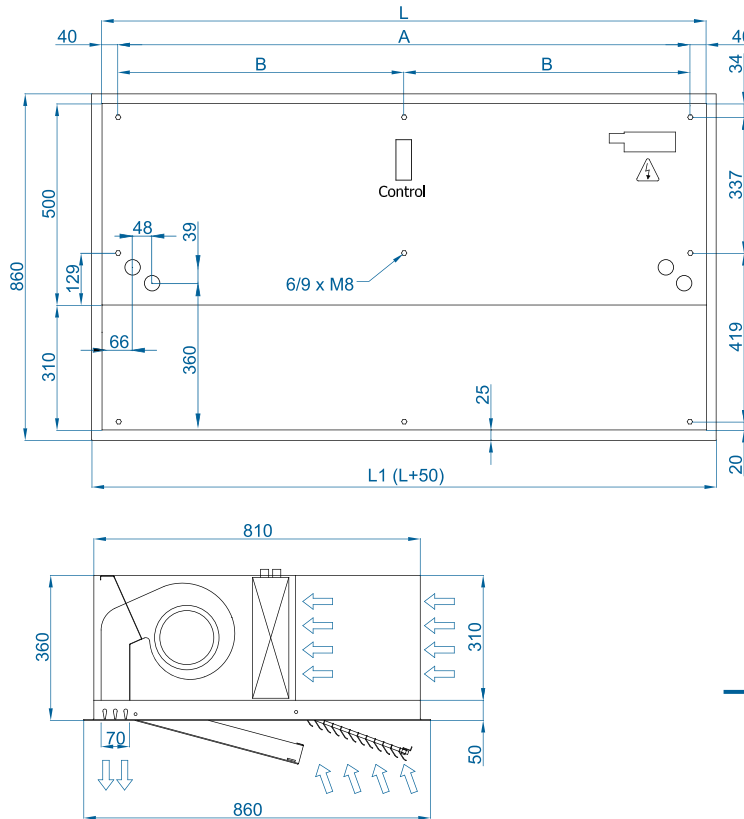

L	A	B
1000	920	-
1500	1420	710
2000	1920	960
2500	2420	1210
3000	2920	1460

CAD drawings, BIM files, installation manuals and other documentation



Optional accessories

Supports and installation



Wall rail support
SPWR



Silentblock supports
SPANG-SIL / SLB



Suspension cables
SPCT

Control



ADVANCED PRO
✓ Included



IR Control
✓ Included



RJ11 Cable
✓ Included



CLEVER PRO

Filters



Removable
prefilter G2

Sensors and valves



Magnetic
door contact MAG-DC
✓ Included



Mechanical
door contact MEC-DC



External Temperature
Sensor



Solenoid valve
V-S



Valve 3 ways
V-T



Proportional valve
V-ACT







Anti-freezing sensor
AFS-INS

Condensation



Condensation tray

MAINTENANCE INSTRUCTIONS

	For safety, before cleaning, stop the curtain through the controller and disconnect the device from the current.
 	Do not open the service door (risk of electric shock and entrapment in the fans). Repairs must be carried out exclusively by authorized personnel.
	The inside of the device must not be cleaned with water or steam.

Indicative periodicity of maintenance

N° Action	Action	Frequency
1	Cleaning of the suction grill	2 weeks (microperforated) / 4 weeks (perforated)*
2	Exterior cleaning	Annual
3	Interior cleaning	Half yearly (perforated) / Yearly (microperforated)
4	Internal inspection	Annual (depending on functioning, installation, etc)
5	Consumption and auditory control	Annual (depending on functioning, installation, etc)
6	Water heating maintenance	Half yearly (quarterly recommended)
7	Electrical heating maintenance	Half yearly (quarterly recommended)

*+/- 1 week if it is a polluted ambient, automatic door, always open or exterior vs interior installation

Inlet grille cleaning

The suction grille prevents the entry of objects into the internal elements. It is a good idea to periodically check that the suction grille is free of any object that could prevent air from entering (plastic bags, paper, etc.). It is recommended to clean the suction grille monthly. In addition, it is important to make sure that the air curtain is off, otherwise the mixture between the dust and a damp cloth would form a paste of dirt that could damage the fan rotor when it sucks in the air or clog the water coil. An annual cleaning of the discharge area must be carried out.



Exterior cleaning

Wipe the entire outer surface of the air curtain (except the suction grille) with a damp cloth to trap dust particles. In addition to the damp cloth, neutral soaps that do not contain acids or are caustic can be used.

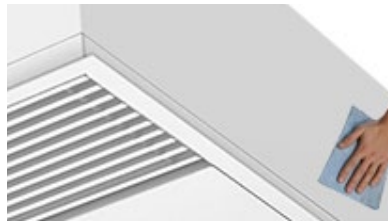

Interior cleaning

It is recommended to clean the inside of the unit with a vacuum cleaner at least once every 2 years. (*) It is recommended to clean the inside of the equipment frequently with the help of a vacuum cleaner, especially before the arrival of winter. (*)

(*) These periods are indicative depending on the conditions of each installation. In places with a high number of suspended particles, it is desirable to increase the frequency of interior cleaning.



Internal components visual inspection

Check that the regulation board(s) have not suffered any damage and that they are securely fastened to the equipment frame. Make sure that the board and internal wiring connectors are still well connected. Check that the fans do not move from their mountings and check that the turbines have no impediments to rotate freely (turn it by hand, first turn off the device).



Air curtain consumption and auditory control checking

Write down the consumption value of the fans that appears on the product label (located on the inside of the service door). Give power to the curtain and with the help of an ammeter, check that the electrical consumption of the curtain at maximum speed is between 110% and 85% of the value indicated on the label. Check that all fans blow air. Keep the curtain at full speed for a few minutes and listen for abnormal noises from the curtain.

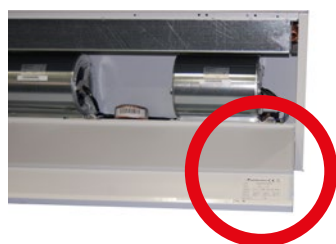

Heating maintenance

To ensure good heat transmission in the air curtain exchanger, it is recommended to check the heating coils as follows:

Coil cleaning

With both electric coils and water coils, the coil must be cleaned periodically with pressurized air.

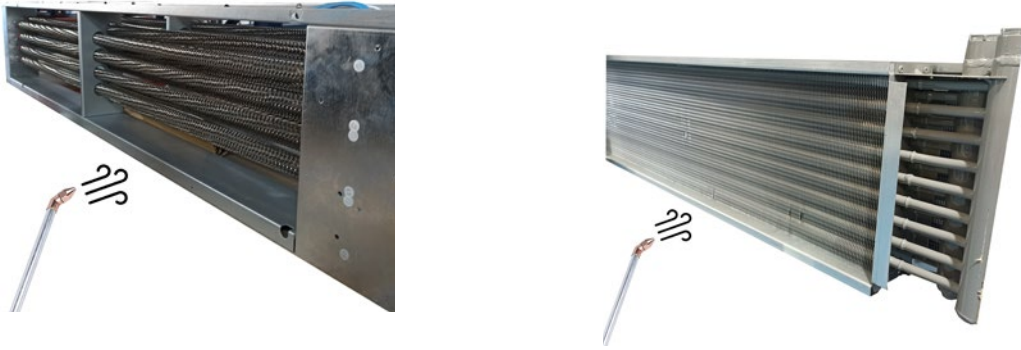

Water coils

Check the inlets and outlets of the water tubes to ensure that there are no fluid leaks.



If a water leak has been detected in the battery, possible corrosion problems in both the battery and the curtain components should be checked.



Electrical heating

Check that no cable has been disconnected from the battery circuit:

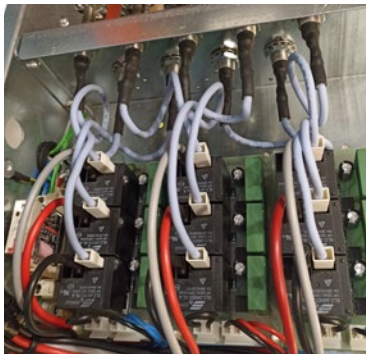

Resistance connection type for models M and ECM in all its lengths and Models G-ECG, SB in lengths 1000 - 1500

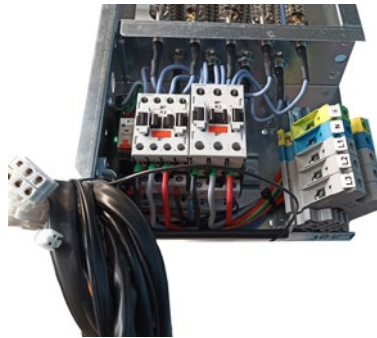

Resistance connection type for models G – ECG, SB in lengths 2000 - 2500 - 3000 and BB all legths

To verify the correct operation of the component, check the battery consumption per heating stage. Theoretical consumptions are shown below:

Air curtain size	Heating stage	M - ECM models		G - ECG models	
		Power by size and heating stage (kW)	Theoretical consumption (A) 400Vx3	Power by size and heating stage(kW)	Theoretical consumption (A) 400Vx3
1000	1	3	4,3	5	7,2
	2	6	8,7	10	14,4
	3	9	13	15	21,7
1500	1	4	5,8	7,5	10,8
	2	8	11,5	15	21,7
	3	12	17,3	22,5	32,5
2000	1	6	8,7	10	14,4
	2	12	17,3	20	28,9
	3	18	26	30	43,3
2500	1	6	8,7	10	14,4
	2	12	17,3	20	28,9
	3	18	26	30	43,3

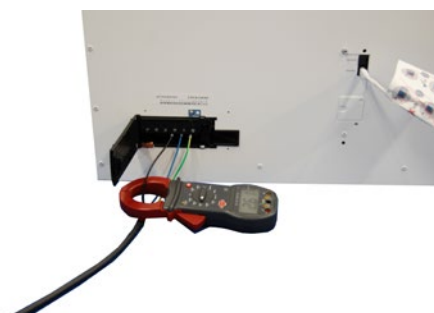

Air curtain size	Heating stage	SB models				BB models			
		Power by size and heating stage (kW)		Theoretical consumption (A) 400Vx3		Power by size and heating stage(kW)		Theoretical consumption (A) 400Vx3	
		ps1	ps2	ps1	ps2	ps1	ps2	ps1	ps2
1000	1	5	-	7,2	-	6	-	8,7	-
	2	10	-	14,4	-	15	-	21,7	-
	3	15	-	21,7	-	21	-	30,3	-
1500	1	7,5	-	10,8	-	8	-	11,5	-
	2	15	-	21,7	-	19	-	27,4	-
	3	22,5	-	32,5	-	27	-	39	-
2000	1	10	-	14,4	-	12	-	17,3	-
	2	20	-	28,9	-	-	30	-	43,3
	3	30	-	43,3	-	12	30	17,3	43,3
2500	1	12	-	17,3	-	16	-	23,1	-
	2	-	22	-	31,7	-	30	-	43,3
	3	12	22	17,3	31,7	16	30	23,1	43,3

REPAIRS AND REPLACEMENTS

Assembly and electrical connection must be carried out exclusively by specialized professionals and in compliance with these instructions.

Before carrying out any repair, it is necessary to:



- **Notify staff and indicate that work is being done.**
- **Disconnect the current and protect the circuit breaker.**



- **Be sure there is no voltage in the unit.**



- **Be sure the fans have stopped.**
- **Use only original spare parts.**



For manipulation safety, being it assembling, transport or maintenance duties it's a must to wear the correct individual protection equipment recommended. Those being gloves, insulating shoes, goggles and helmet.



CODE	COMPONENT	COMPONENT REFERENCE	AIR CURTAIN MODEL
AIRCON12655	AC Windbox 5 speed PCB	PCB-5SA-AIR-RJ11	M - G : Air
AIRCON12657	EC Windbox 5 speed PCB	PCB-5SE-AIR-RJ11	ECM - ECG - SB - BB: Air
AIRCON12660	AC Windbox 5 speed electrical battery PCB	PCB-5SA-ELE-RJ11	M - G : Electrical
AIRCON12663	AC Windbox 5 speed water 0-10V PCB	PCB-5SA-WAT/0-10-RJ11	M - G : Water
AIRCON12666	AC Windbox 5 speed water 230V PCB	PCB-5SA-WAT-RJ11	M - G : Water
AIRCON12672	EC Windbox 5 speed electrical battery PCB	PCB-5SE-ELE-RJ11	ECM - ECG - SB - BB: Electrical
AIRCON12675	EC Windbox 5 speed water 0-10V PCB	PCB-5SE-WAT/0-10-RJ11	ECM - ECG - SB - BB: Water
AIRCON12678	EC Windbox 5 speed water 230V PCB	PCB-5SE-WAT-RJ11	ECM - ECG - SB - BB: Water
AIRSEC99205	2 poles AC centrifugal fan	2GDS35 133X190L P15-A3 AC	G: All models M: Water (P86, P64 , P54)
AIRSEC99215	4 poles AC centrifugal fan	4GDS35 146X188 N46-A1 AC	M: Air and electrical
AIRSEC99210	EC centrifugal fan	GDSG9 146X188R N46-A0 EC	ECM - ECG: All models
AIRSEC50130	EC centrifugal fan for SB	G9GDS 146x188L Y02-D5	SB: All models
AIRSEC50190	EC centrifugal fan for BB	GDSV8 160X198L Q39-B0-1	BB: All models
ELACCO33005	ADVANCED PRO Control RJ11	CON-LCD-RJ11	All models

Service door opening

Recessed Windbox model

1. Insert a flat screwdriver between frame and grille and push grille out. The grille is closed by pressure with pivots. It has a safety cable to prevent accidental falls from the gate.



2. Remove the two safety screws from the service door.

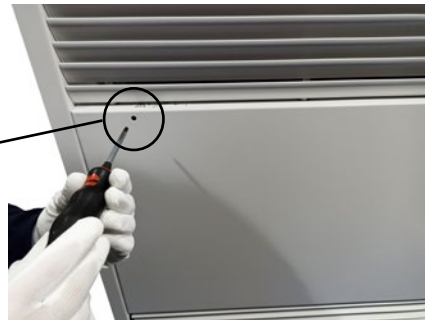
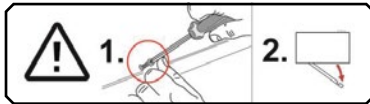

3. Raise the grate of the service door to be able to open the panel. Open the panel, being careful not to drop the grate of the service door. Once the service panel grille is closed with the service door open, open the service door fully with both hands



Recessed Dam model and Recessed Compact

Remove the two safety screws from the curtain (one on each side of the grille) and open the suction grille with both hands

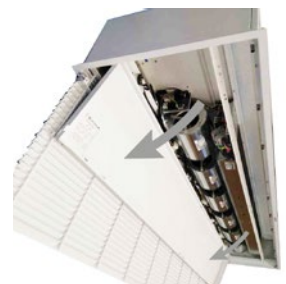

Pass 4th of opening the the suction grille is exclusively of the Recessed Dam model.

Fan replacement

Before changing the fan, notify and indicate that it is working, disconnect the power supply, making sure that there is no voltage and that the fans have stopped.

Next, identify and release the fan cables. Remove the fan by loosening the two fixing screws (one on each side) and mount the replacement fan following the process in reverse order.

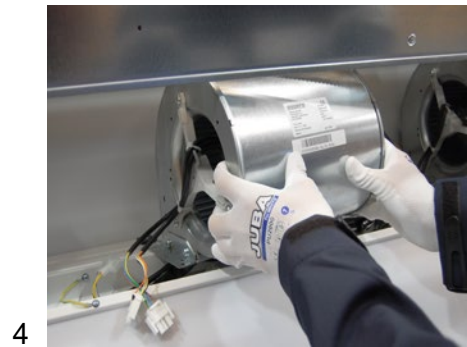
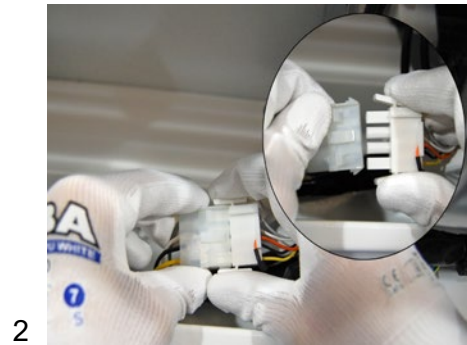

Replacement of the power board or fuse

Before changing the power board or fuse, notify and indicate that work is being done, disconnect the power supply, make sure that there is no voltage and that the fans have stopped.

Fuse changing: open the service door and remove the fuse by hand or with the help of a screwdriver by pressing towards the board, turning it counterclockwise. In some cases, it is recommended to unscrew the PCB.

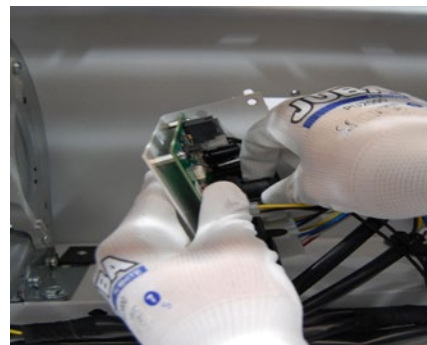

Power board change: open the service door and unscrew the power board from the inside of the air curtain to remove the plate and carry out the necessary repair.

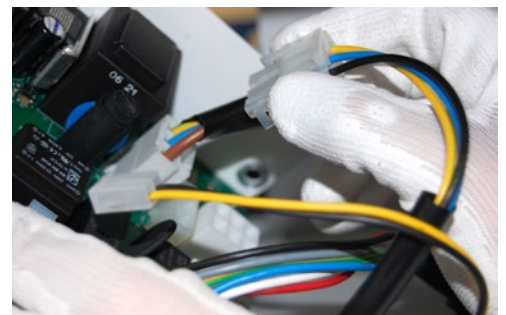
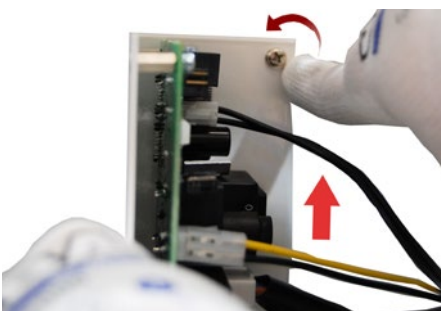

Recommendation: installation with silentblocks

To reduce the sound level and the vibrations of the air curtain, it is recommended to carry out an installation with silentblocks:



Heater replacement

Water coils: close the building's water inlet and outlet valves up to the air curtain. Open the suction grille and drain the water coil with the drain plug of the main collector as shown in the photograph and disconnect the coil from the installation.

Warning! The curtain is not ready to work in cold mode. Do not circulate cold water through the battery. Before changing the battery, notify and indicate that you are working, disconnect the power supply, make sure that there is no voltage and that the fans have stopped. Before removing the screws that secure the coil:



To remove the water coil, unscrew the fixing screws as shown on the next page:

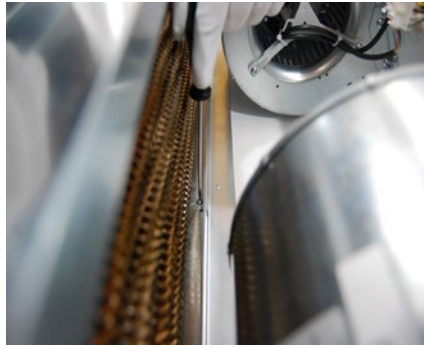
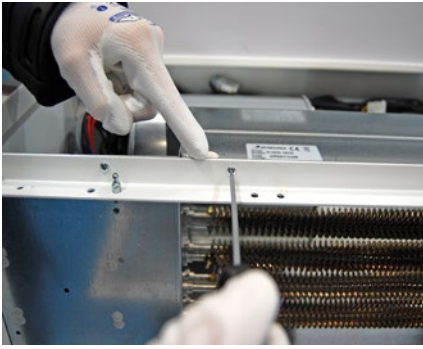

Electrical heaters: disconnect the power supply from the heater itself.

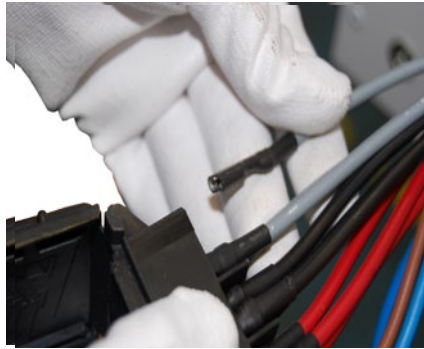
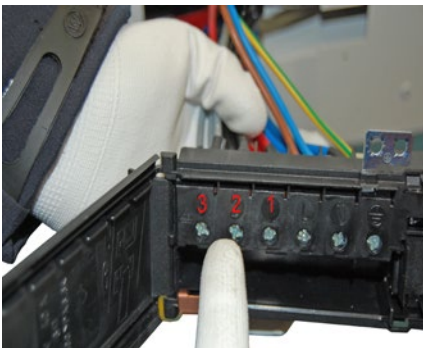

In case of having a contactors battery, disconnect the electrical wires inside the air curtain.

Recessed Windbox and Recessed DAM model

Water and electric coil fixing points: door closing angle and interior angles.

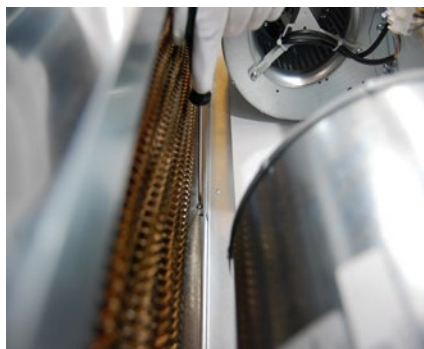

Air curtain size	N° angle fixing points
1000	1
1500	2
2000	3
2500	4

TROUBLESHOOTING

More than 95% of the claims occur **during the start-up** of the equipment and **are due to installation errors**. Reviewing the following points solves more than 90% of the incidents:

A) RJ11 cable manipulated: the cable connecting the control to the air curtain is an 4-way RJ11 cable. If it is manipulated (cut or remove the connector) and spliced backwards, the shade will not work properly and may also damage the electronics. Only re-splicing the connector correctly solves the problem (connection diagram).

B) Incorrect power supply. The supply of the air curtain depends on the type of current available and the type of heating of the equipment. Check bounding jumper if required, according to the wiring diagram.

Most commons problems and solutions		
Symptom	Problem	Solution
No light on LCD control	Is the RJ11 cable the original without splices or shortening?	Change the cable or reconnect it correctly.
	Does the current reach the connection box?	Correctly connect the terminals of the connection box: Between L and N there must be 230V. If the curtain has a three-phase electric battery, there must be 400V between terminals L1, L2 and L3.
	Is the fuse on the board in good condition?	Check the fuse and change it if necessary (type T, slow action).
The heating does not work	Does the three-phase current reach the connection box?	Check installation.

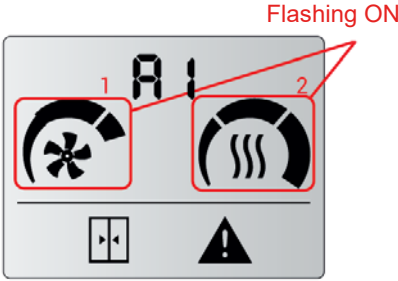
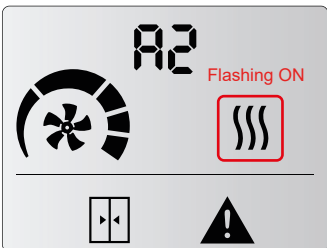
Alarms Lists		
Comment	Problem and Alert	Solution
Alarms will remain fixed on the display because it affects to the device functioning. Some lights on the remote control flash and an alert sign will appear in the display. Alarms will be shown as an "A" followed by a number to indicate the code of the alarm.	Overheating (only electrical heated) (A1) 	When the unit goes into overheating, it starts a process to cool it down. The ventilation starts to rise up to the maximum each 2 minutes. If overheating persists, the heating is turned down each 2 minutes until it is switched off. If it is still not solved, after 2 minutes heating is blocked and alarm A2 is activated (check A2).
	Heating blocked (only electrical heated) (A2) 	The heating is blocked and switched off. It is the overheating safety program. Service must check the unit and fix the problem to avoid internal damages. Once solved, reset the unit.

Alarms Lists

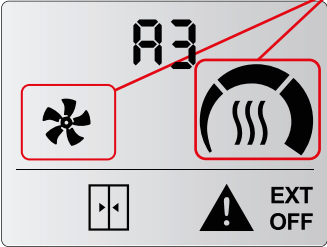
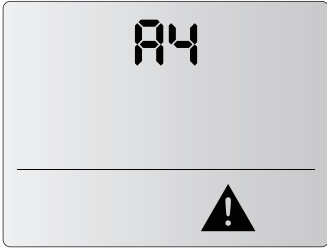
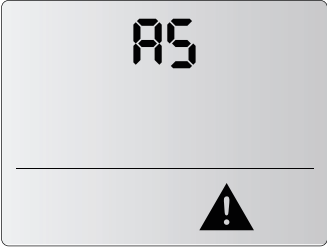
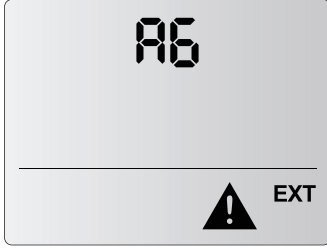
Comment	Problem and Alert	Solution
<p>Alarms will remain fixed on the display because it affects to the device functioning. Some lights on the remote control flash and an alert sign will appear in the display. Alarms will be shown as an "A" followed by a number to indicate the code of the alarm.</p>	<p>Antifreezing (only water heated) (A3) Flashing ON</p> 	<p>When ambient temperature is below anti-freezing temperature set (5°C), the valve opens to protect the water coil and the fan stops functioning. It can be also activated by external anti-freezing sensor connected to the PCB or a discharge temperature sensor installed on the air curtain PCB.</p>
	<p>Communications error (A4)</p> 	<p>No unit found. When this error appears, the user can do a scan to find the PCBs pressing the ON/OFF button during 10 seconds.</p>
	<p>Inappropriate device (A5)</p> 	<p>Wrong combination of 2 different heatings (electric with water or heat pump) It is only possible to mix unheated units with one type of heating units.</p>
	<p>Fire Alarm (A6)</p> 	<p>Stops and locks the unit. To unlock it, the power supply must be switched off. It is activated with DIN3 digital IN on the control unit.</p>

Error Lists

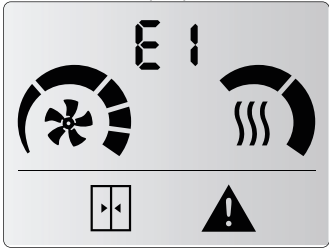
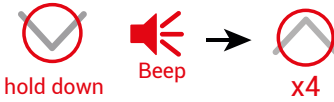
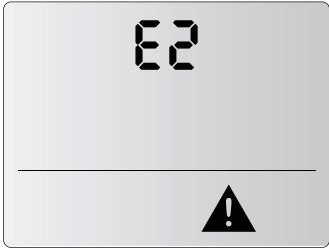
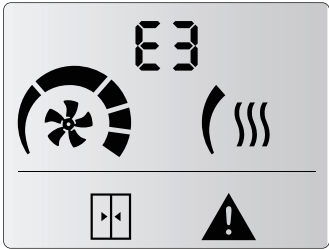
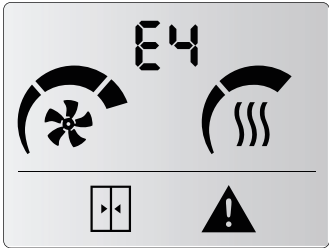
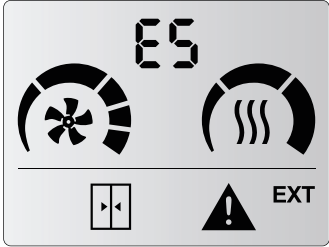
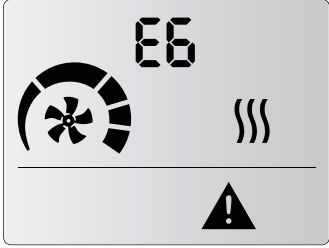
Comment	Problem	Solution
<p>Errors will not remain on the display, they will alternate with the ambient temperature. Unit operation remains working normal or adapted. Some lights on the remote control flash and an alert sign will appear in the display. Errors will be shown as an "E" followed by a number to indicate the code of the error.</p>	<p>Filter/maintenance (E1)</p> 	<p>Indicates filter change or cleaning / maintenance. This alarm is activated by time counter. It does not affect operation. To reset the counter:</p> 
	<p>Missing device (E2)</p> 	<p>One of the working units is not found. Please consult service to check the unit. To reset, turn OFF the power or scan the other PCBs by pressing the ON/OFF button during 10 seconds. Other devices remain working normally. Check the connections between units to see that none is wrongly connected.</p>
	<p>Missing temperature sensor (E3)</p> 	<p>Missing temperature sensor or temperature out of range. Unit operation adapts and remains working according to inbuilt room temperature sensor.</p>
	<p>Fan Error (E4)</p> 	<p>Some fan has stopped. Check the unit. Unit operation remains normal. Not available in 2-speed range.</p>
	<p>External Alarm (E5)</p> 	<p>Indicates an external alarm. Unit operation remains normal. Only programmable with CLEVER PRO control (consult CLEVER PRO Manual).</p>
	<p>E6 - Additional PCB Error</p> 	<p>Additional PCB inside the same air curtain has an error or is disconnected. In case of electrical heater, heating stops.</p>

DECLARATION OF CONFORMITY



KE047BB00121A4_NSPRL_EMV_RoHS_ErP

EU-Konformitätserklärung / *EU-Declaration of conformity*

Im Sinne der Niederspannungsrichtlinie 2014/35/EU, der EMV-Richtlinie 2014/30/EU, der ErP-Richtlinie 2009/125/EG und der RoHS Richtlinie 2011/65/EU
as defined by the low voltage directive 2014/35/EU, the EMC-directive 2014/30/EU, the ErP-directive 2009/125/EG and the RoHS-directive 2011/65/EU

Hersteller / *Manufacturer*

Rosenberg Ventilatoren GmbH
Maybachstraße 1
D- 74653 Gaisbach

Für die nachfolgende Maschine / *For the following machine*

Produktbezeichnung / <i>Designation of the machine:</i>	Typ- oder Serienbezeichnung / <i>Model or type of machine</i>
Luftschleier / <i>Air Curtains</i>	Minibel, Optima, Recessed Optima, Optima Wireless, Recessed Optima Wireless, Optima K, Optima Switch, Recessed Optima Switch, Top, Recessed Compact, Aris, Windbox, Recessed Windbox, Smart, Dam, Recessed Dam, Deco, Kool, Rund, Invisair, Rotowind, Variowind, Zen, Max, Maxwell, Compact Fly, Fly K, Fly KL-KXL, Fly KBB, Windbox BB, Recessed Windbox BB, Zen BB, Invisair BB, Kool BB, Rotowind BB, Zen L-XL, Windbox L-XL, Duojet, Triojet System - Included are all Air Curtains DX series

erklären wir in alleiniger Verantwortung, dass sie den grundlegenden Anforderungen entsprechen, die in den nachfolgend bezeichneten Harmonisierungsrechtsvorschriften festgelegt sind.

we declare under our sole responsibility, that they meet the basic requirements that are laid down in the harmonization legislation designated below.

- **Niederspannungsrichtlinie (2014/35/EU) / *Low voltage directive (2014/35/EU)***
- **EMV-Richtlinie (2014/30/EU) / *EMC-Directive (2014/30/EU)***
- **RoHS-Richtlinie (2011/65/EU) / *RoHS-Directive (2011/65/EU)***
- **ErP-Richtlinie (2009/125/EG) / *ErP Directive (2009/125/EC)***

Folgende harmonisierte Normen wurden angewandt / *The following harmonized standards were applied:*

EN 60335-1: 2012 + AC:2014 + A11:2014 + A13:2017 + A1:2019 + A14:2019 + A2:2019	EN 55014-1:2017 + A11:2020
EN 60335-2-30: 2009 + A11:2012 + A1:2020 + A12:2020	EN 55014-2:2015
EN 61000-3-11:2020	EN 62233:2008 + AC:2008
EN 61000-3-12:2011	EN 50581:2012

Diese Konformitätserklärung zur Einhaltung der EMV-Richtlinie bezieht sich ausschließlich auf gemäß der Betriebsanleitung angeschlossene und eigenständig betriebene Ventilatoren bei sinusförmiger Stromversorgung. Beim Einbau der Maschine in eine Anlage sowie sonstige Ergänzungen (z.B. Anschluss von Reglern) ist der Hersteller der Anlage für die Einhaltung der EU-Richtlinien verantwortlich.

This declaration of conformity to the compliance with EMC-Directive is valid only for fans which are connected according to the operating instructions and operated independently in reference to sinusoidal current supply. The Manufacturer of this completed system is responsible for the compliance with the EU-directives in case of integration in it or to other component such as controllers.

Die EU-Konformitätserklärung wurde ausgestellt von / *EU-Declaration of conformity was issued by:*

Gaisbach, Germany, 22.07.2024

Ort, Datum / Place, Date

i.A. Andreas Ohm

(Technische Leitung Ventilatoren /
Technical Director Fans)

IDENTIFICATOR

Model Typ WINDBOX M 3000 E Artikelnummer:			
Airflow Luftstrom 5400 m3/h			
Blowers Ventilatoren 2,82 A 0,636 kW 230 V/50Hz			
Heating Heizung		Temperature Temperatur	Capacity Leistung
Water Coil Wasserspule		°C	kW
Electric Heater elektrische Heizung		8/16/24 kW	400V-3 50Hz
Serial Number Serie Nummer 2025-05-30 / 143.389			

AIRCOR15722 143389
 WINDBOX M 3000 E www.airtechnics.com

Each air curtain is identified by a unique serial number printed in a label located inside the door service. There is also indicated the model and their technical characteristics (flow, fans technical characteristics and power heating). It is indispensable to have this number to facilitate possible replacements or technical information of the air curtain in question.

GUARANTEE

Your air curtain is guaranteed for a period of two years from the date of purchase. We will adjust, repair or replace at our discretion from our warehouse any defect, system failure or part found to be defective. The assembly cost out of our warehouse is at buyer expense. The products that, in our eyes, have been inadequately used, incorrectly manipulated, improperly installed, connected to different nominal tensions, modified, repaired by non-authorized workers or that have suffered damages during transport are totally excluded from the guarantee.

*To validate the guarantee it should be correctly filled and enclosed with the invoice that vouches for the buying date. If it is manipulated, it will lose all validity.
It is the buyer's responsibility to take the necessary safety measures because in case of a failure or mistake in one of our products, no damages to third parties, sets or installations will occur.*

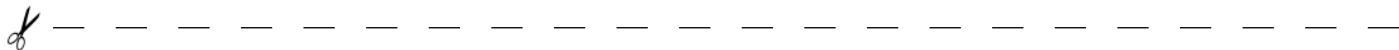

Guarantee draft

Air curtains data:

Model: Series number:
 Invoice date:..... Invoice number:

Buyer data:

Name:
 Adress:
 Country: Phone: Mail:.....

Seller data:

Name:
 Adress
 Country: Phone: Mail:.....

Buyer signature and stamp

Seller signature and stamp

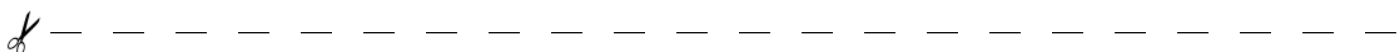

*If you detect some error in this manual, we'll be pleased to receive your feedback, it helps us to improve even more.
Airtécnics reserves the right to modify some of the specifications in this manual*

Rosenberg Ventilatoren GmbH
Maybachstraße 1 - D-74653 Künzelsau- Gaisbach
☎ +49 (0) 7940/142-0
info@rosenberg-gmbh.com

www.rosenberg-gmbh.com

AIRDOM05762-R0(10/25) ORIGINAL MANUAL

Rosenberg Ventilatoren GmbH reserves the right to modify some of the specifications in this manual.